

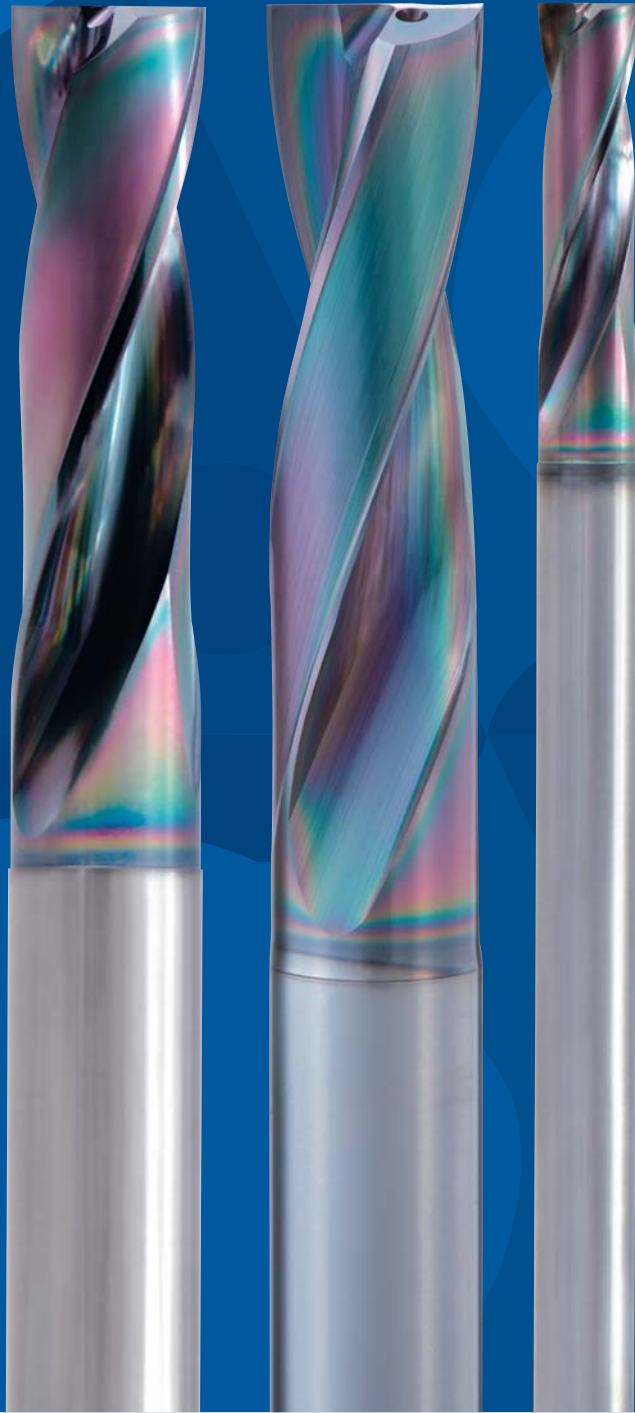

Carbide flat drills with/without internal coolant & for deep reach

ADF Series

Volume 5.4



KEY FEATURES: ADF SERIES

- 
- 1** Carbide flat drill with or without internal coolant
 - 2** Designed for a wide variety of applications
 - 3** New EgiAs Coating: exceptional wear resistance & toughness
 - 4** Unique end cut geometry for stable cutting resistance
 - 5** 20° helical grooves with high rigidity
 - 6** ADFLS for deep reach flat drilling application



KEY FEATURES & BENEFITS

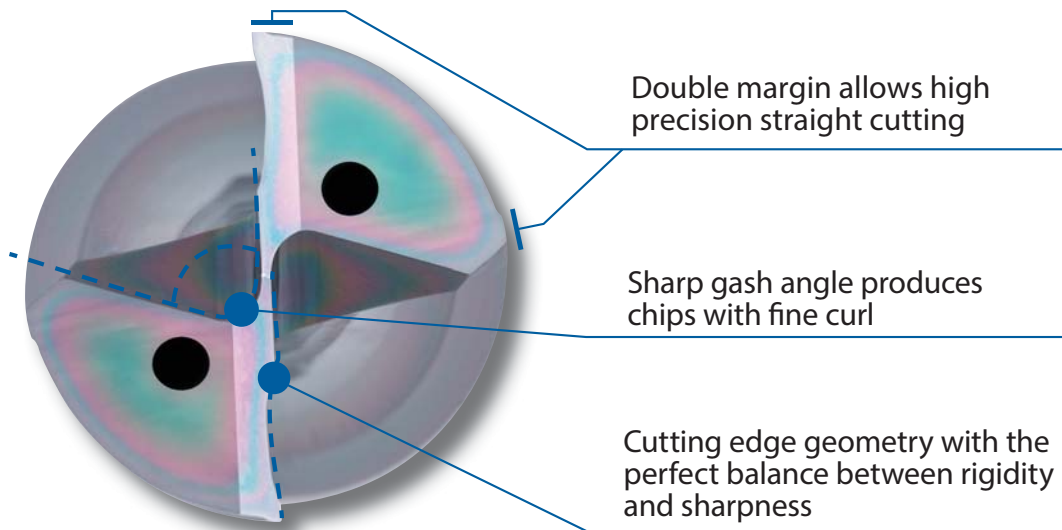

1 One drill does it all

Applicable for a multitude of drilling applications such as inclined surface, curved surface, flat-bottom hole, eccentric hole, and more.

Standard lineup for thread forming of pilot holes under M6

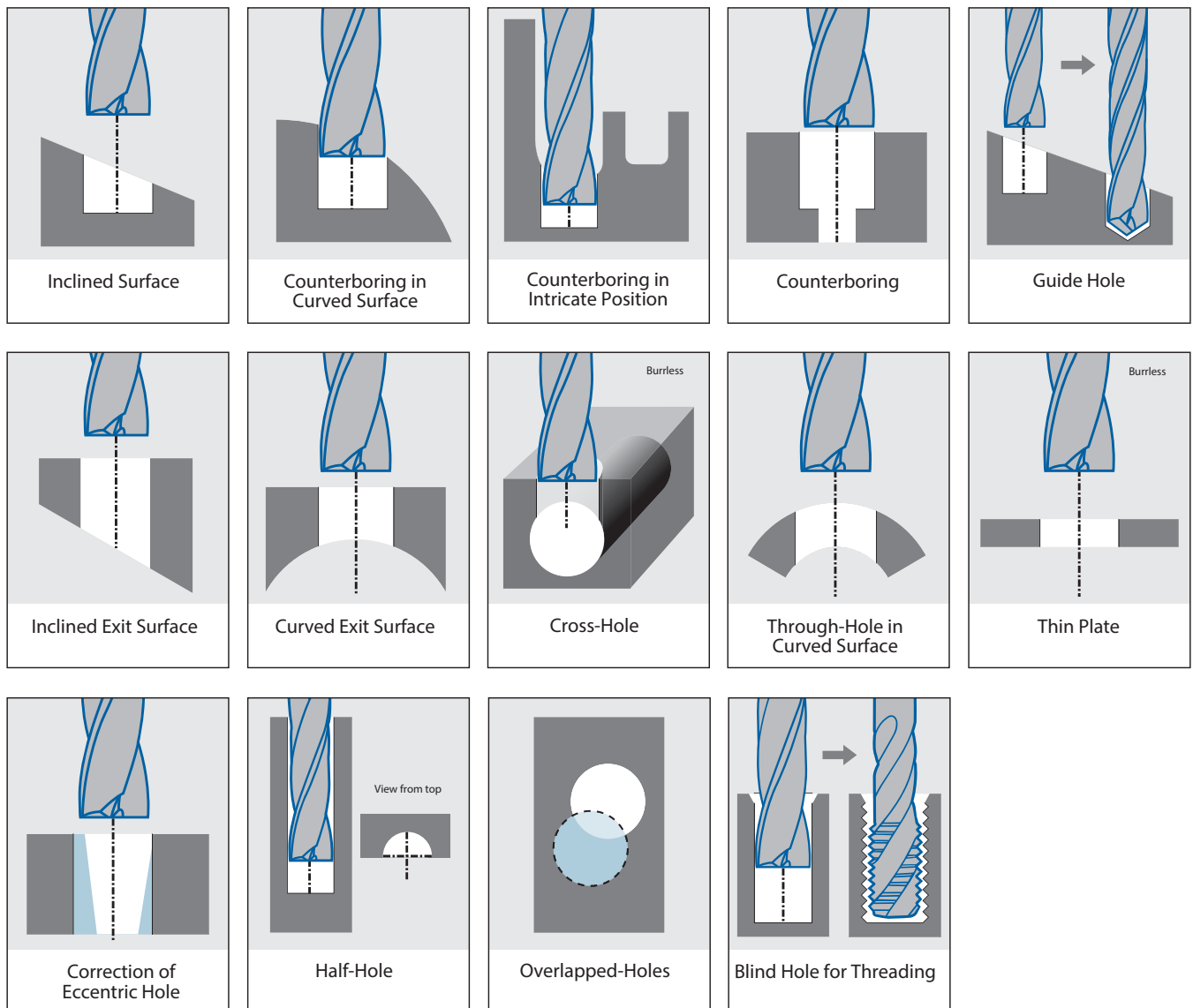

Radial cutting is not recommended.

KEY FEATURES & BENEFITS

2 New coating: EgiAs

Exceptional wear resistance & toughness

Suppresses friction with the wear resistance layer; prevents breakage with the nano periodical layer.

Tool	ADF-2D Ø6
Machined Surface	(30°) Angled Surface
Work Material	S50C
Cutting Speed	75m/min (3.981 min ⁻¹)
Feed Rate	239 mm/min (0,06 mm/rev)
Depth of Hole	12 mm (Blind)
Coolant	Water Soluble
Machine	Horizontal Machining Center

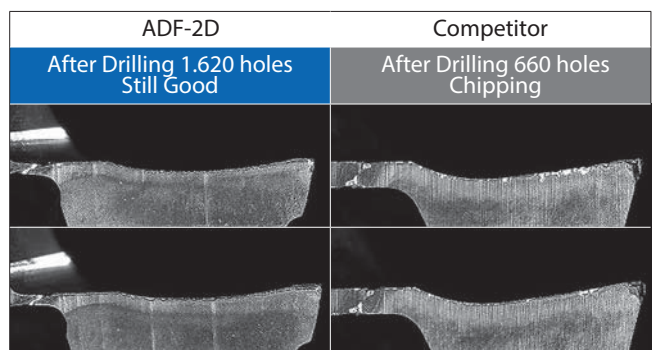
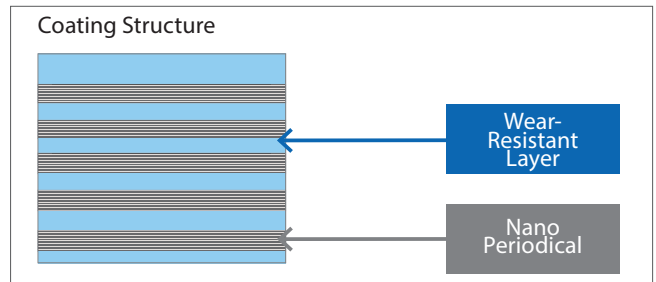

3 End cut geometry

Stable cutting resistance

Unique end cut geometry reduces cutting force to enable stable machining.

Tool	ADF-2D Ø10
Machined Surface	Flat Surface
Work Material	S50C
Cutting Speed	60m/min (1.911 min ⁻¹)
Feed Rate	382 mm/min (0,2 mm/rev)
Depth of Hole	20 mm (Blind)
Coolant	Water Soluble
Machine	Vertical Machining Center

Cutting resistance wave form

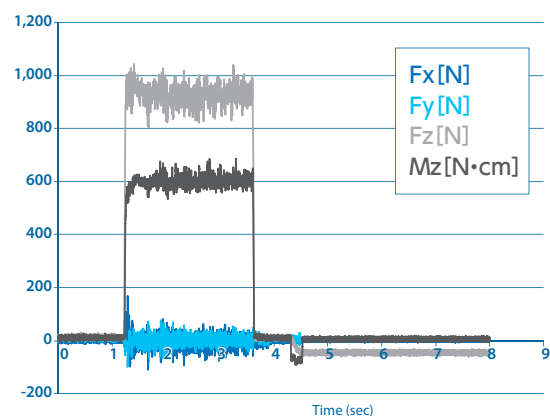



Oversize

Mouth **0,01mm** Depth of hole **0,01mm**

KEY FEATURES & BENEFITS

ADF-2D • ADFLS-2D / ADFO-3D

Application guide

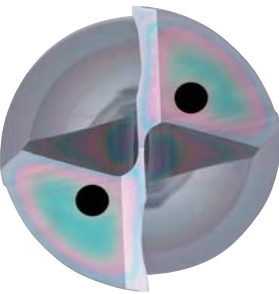
ADF-2D•ADFLS-2D	ADFO-3D
 <p>Non Oil Hole</p>  <ul style="list-style-type: none"> • General purpose • Suitable up to 2D • Suitable for a wide variety of applications 	 <p>with Oil Hole</p>  <ul style="list-style-type: none"> • Suitable up to 3D • Suitable for stainless steel

■ Breaks chips into small, manageable pieces



SUS304 Work Material : SUS304



■ IchAda coating with excellent surface smoothness

The excellent smoothness in conjunction with high abrasion resistance and heat resistance enable small diameter tools to achieve long tool life

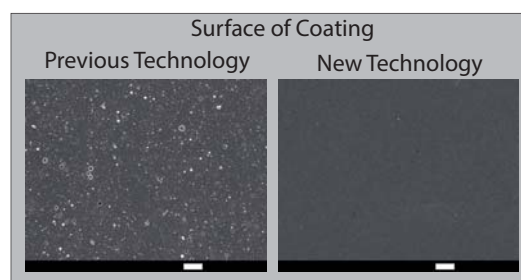

■ EgiAs coating with high toughness and wear resistance characteristics

Constructed with extreme toughness, high wear and heat resistance characteristics to ensure stable and consistent tool life

EgiAs

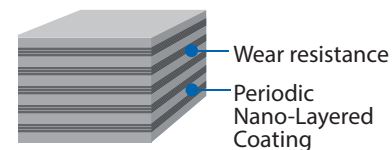

Name of Coating	Coating Color	Coating Structure	(GPa) Hardness	(°C) Oxidation Temperature	Heat Resistance	Adhesion Strength	Surface roughness	Wear Resistance	Welding Resistance	Toughness
IchAda	Black Gray	Cr Series Single Layer	39	1.100	◎	◎	☆	◎	◎	○
EgiAs	Interference Color	Cr, Si Nano Periodical Layer	40	1.100	◎	◎	○	◎	◎	◎

(Fair) ○ → ◎ → ☆ (Best)

EgiAs & IchAda are a registered trademark of OSG Corporation.

ADF-2D NEW SIZES

Drilling | Solid carbide | Flat drills

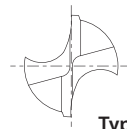

Type 1

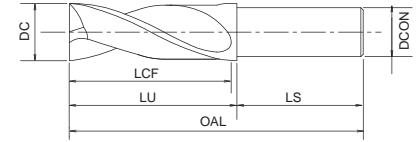
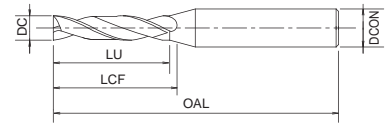

Type 2

- First choice in quality and performance
- Carbide drill with EgiAs coating
- Up to 2xD
- Flat drilling application
- 253 sizes

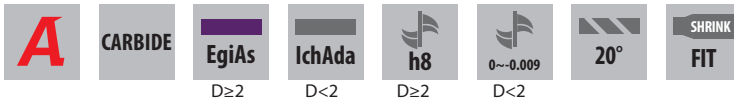

Drilling | Solid carbide

Flat drills

EDP	DC	LU	LCF	OAL	DCON	Type
3330020	0,2	0,6	0,7	40	3	1
3330025	0,25	0,8	0,9	40	3	1
3330030	0,3	0,9	1	40	3	1
3330035	0,35	1,1	1,2	40	3	1
48315037	0,37	1,2	1,4	40	3	1
3330040	0,4	1,2	1,3	40	3	1
3330045	0,45	1,4	1,5	40	3	1
48315046	0,46	1,5	1,7	40	3	1
3330050	0,5	1,7	1,9	40	3	1
3330055	0,55	1,9	2,1	40	3	1
3330060	0,6	2	2,2	40	3	1
48315062	0,62	2,1	2,3	40	3	1
3330065	0,65	2,2	2,4	40	3	1
3330070	0,7	2,4	2,6	40	3	1
3330071	0,71	2,4	2,6	40	3	1
3330072	0,72	2,4	2,6	40	3	1
3330074	0,74	2,5	2,7	40	3	1
3330075	0,75	2,6	2,8	40	3	1
3330080	0,8	2,7	2,9	40	3	1
3330081	0,81	2,8	3	40	3	1
3330085	0,85	2,9	3,1	40	3	1
48315087	0,87	3	3,2	40	3	1
48315088	0,88	3	3,2	40	3	1
3330089	0,89	3	3,2	40	3	1
3330090	0,9	3,1	3,3	40	3	1
3330091	0,91	3,1	3,3	40	3	1
3330092	0,92	3,1	3,3	40	3	1
3330095	0,95	3,2	3,4	40	3	1
3330100	1	4	4,3	45	3	1
48315104	1,04	4,5	4,2	45	3	1
48315105	1,05	4,5	4,2	45	3	1
3330109	1,09	4,4	4,7	45	3	1
3330110	1,1	4,4	4,7	45	3	1
3330111	1,11	4,4	4,7	45	3	1
3330112	1,12	4,5	4,8	45	3	1
48315115	1,15	4,6	4,9	45	3	1
48315116	1,16	4,6	4,9	45	3	1
3330120	1,2	5	5,1	45	3	1
3330125	1,25	5	5,3	45	3	1
3330126	1,26	5,1	5,3	45	3	1
3330127	1,27	5,1	5,4	45	3	1
3330128	1,28	5,2	5,4	45	3	1
3330129	1,29	5,2	5,5	45	3	1
3330130	1,3	5,2	5,5	45	3	1
48315132	1,32	5,6	5,3	45	3	1
48315133	1,33	5,6	5,3	45	3	1

EDP	DC	LU	LCF	OAL	DCON	Type
3330135	1,35	5,4	5,7	45	3	1
3330140	1,4	5,6	5,9	45	3	1
48315143	1,43	6	5,7	45	3	1
3330144	1,44	5,8	6,1	45	3	1
3330145	1,45	5,8	6,1	45	3	1
3330146	1,46	5,8	6,1	45	3	1
3330147	1,47	5,9	6,2	45	3	1
3330148	1,48	5,9	6,2	45	3	1
3330150	1,5	6	6,3	45	3	1
48315152	1,52	6,1	6,4	45	3	1
3330153	1,53	6,1	6,4	45	3	1
3330154	1,54	6,2	6,5	45	3	1
3330155	1,55	6,2	6,5	45	3	1
3330156	1,56	6,2	6,5	45	3	1
3330157	1,57	6,3	6,6	45	3	1
3330158	1,58	6,3	6,6	45	3	1
3330160	1,6	6,4	6,7	45	3	1
48315165	1,65	6,6	6,9	45	3	1
48315167	1,67	6,7	7	45	3	1
48315168	1,68	6,7	7	45	3	1
3330170	1,7	6,8	7,1	45	3	1
3330175	1,75	7	7,3	45	3	1
3330180	1,8	7,2	7,5	45	3	1
3330182	1,82	7,3	7,6	45	3	1
3330183	1,83	7,3	7,6	45	3	1
3330184	1,84	7,4	7,7	45	3	1
3330185	1,85	7,4	7,7	45	3	1
3330186	1,86	7,4	7,7	45	3	1
3330190	1,9	7,6	7,9	45	3	1
3330195	1,95	7,8	8,1	45	3	1
48315199	1,99	8	8,3	45	3	1
3330200	2	10	10,3	50	4	1
3330210	2,1	10	10,5	50	4	1
3330220	2,2	10,6	11	50	4	1
3330230	2,3	10,8	11	50	4	1
3330232	2,32	10,9	11	50	4	1
3330240	2,4	11	12	50	4	1
3330242	2,42	11,1	12	50	4	1
3330250	2,5	11,2	12	50	4	1
3330254	2,54	11,3	12	50	4	1
3330258	2,58	11,4	12	50	4	1
3330260	2,6	11,4	13	50	4	1
3330270	2,7	11,6	13	50	4	1
3330276	2,76	11,7	14	50	4	1
3330278	2,78	11,7	14	50	4	1
3330280	2,8	11,8	14	50	4	1

ADF-2D

Drilling | Solid carbide | Flat drills

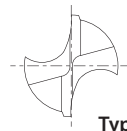

Type 1

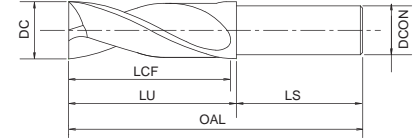
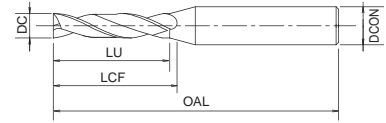

Type 2

- First choice in quality and performance
- Carbide drill with EgiAs coating
- Up to 2xD
- Flat drilling application
- 253 sizes

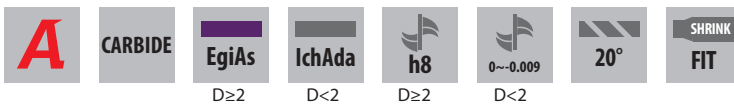

EDP	DC	LU	LCF	OAL	DCON	Type
3330290	2,9	11,9	14	50	4	1
3330300	3	11,4	15	55	6	1
3330303	3,03	11,5	15	55	6	1
3330310	3,1	11,6	15	55	6	1
3330315	3,15	11,7	15	55	6	1
3330320	3,2	11,8	15	55	6	1
3330330	3,3	12	15	55	6	1
3330340	3,4	12,1	16	55	6	1
3330350	3,5	12,3	16	55	6	1
3330353	3,53	12,4	16	55	6	1
3330360	3,6	12,5	16	55	6	1
3330366	3,66	12,6	16	55	6	1
3330368	3,68	12,7	16	55	6	1
3330370	3,7	12,7	16	55	6	1
3330380	3,8	17,9	19	60	6	1
3330390	3,9	18,1	19	60	6	1
3330400	4	18,3	19	60	6	1
3330403	4,03	18,3	19	60	6	1
3330410	4,1	18,5	19	60	6	1
3330420	4,2	18,6	21	60	6	1
3330430	4,3	18,8	21	60	6	1
3330440	4,4	19	21	60	6	1
3330450	4,5	19,2	21	60	6	1
3330453	4,53	19,3	21	60	6	1
3330460	4,6	19,4	21	60	6	1
3330462	4,62	19,4	21	60	6	1
3330464	4,64	19,5	21	60	6	1
3330470	4,7	19,6	21	60	6	1
3330480	4,8	24	24,8	65	6	1
3330490	4,9	24	24,9	65	6	1
3330500	5	24	25,1	65	6	1
3330503	5,03	24	25,2	65	6	1
3330510	5,1	24	25,3	65	6	1
3330520	5,2	24	25,5	65	6	1
3330530	5,3	24	25,7	65	6	1
3330540	5,4	25,9	27	65	6	1
3330550	5,5	26,1	27	65	6	1
3330552	5,52	26,1	27	65	6	1
3330554	5,54	26,1	27	65	6	1
3330560	5,6	26,3	27	65	6	1
3330570	5,7	26,4	27	65	6	1
3330580	5,8	26,6	27	65	6	1
3330590	5,9	26,8	27	65	6	1
3330600	6	27	27	65	6	2
3330603	6,03	32	30	70	6	2
3330610	6,1	32	30	70	6	2

EDP	DC	LU	LCF	OAL	DCON	Type
3330620	6,2	32	30	70	6	2
3330630	6,3	32	30	70	6	2
3330640	6,4	32	30	70	6	2
3330650	6,5	32	30	70	6	2
3330653	6,53	32	30	70	6	2
3330660	6,6	32	30	70	6	2
3330670	6,7	32	30	70	6	2
3330680	6,8	32	30	70	6	2
3330690	6,9	32	30	70	6	2
3330700	7	32	30	70	6	2
3330703	7,03	36	34	75	6	2
3330710	7,1	36	34	75	6	2
3330720	7,2	36	34	75	6	2
3330730	7,3	36	34	75	6	2
3330740	7,4	36	34	75	6	2
3330750	7,5	36	34	75	6	2
3330760	7,6	36	34	75	6	2
3330770	7,7	36	34	75	6	2
3330780	7,8	36	34	75	6	2
3330790	7,9	36	34	75	6	2
3330800	8	36	34	75	8	2
3330803	8,03	40	38	80	8	2
3330810	8,1	40	38	80	8	2
3330820	8,2	40	38	80	8	2
3330830	8,3	40	38	80	8	2
3330840	8,4	40	38	80	8	2
3330850	8,5	40	38	80	8	2
3330853	8,53	40	38	80	8	2
3330860	8,6	40	38	80	8	2
3330870	8,7	40	38	80	8	2
3330880	8,8	40	38	80	8	2
3330890	8,9	40	38	80	8	2
3330900	9	40	38	80	8	2
3330903	9,03	44	42	85	8	2
3330910	9,1	44	42	85	8	2
3330920	9,2	44	42	85	8	2
3330930	9,3	44	42	85	8	2
3330940	9,4	44	42	85	8	2
3330950	9,5	44	42	85	8	2
3330960	9,6	44	42	85	8	2
3330970	9,7	44	42	85	8	2
3330980	9,8	44	42	85	8	2
3330990	9,9	44	42	85	8	2
3331000	10	44	42	85	10	2
3331003	10,03	48	46	90	10	2
3331010	10,1	48	46	90	10	2

ADF-2D

Drilling | Solid carbide | Flat drills

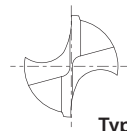

Type 1

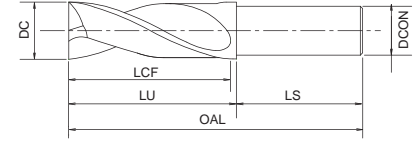
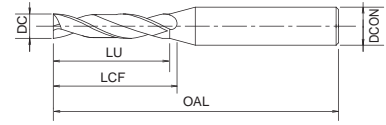

Type 2

- First choice in quality and performance
- Carbide drill with EgiAs coating
- Up to 2xD
- Flat drilling application
- 253 sizes

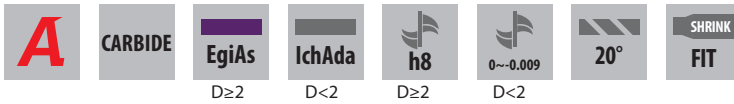

Drilling | Solid carbide

Flat drills

EDP	DC	LU	LCF	OAL	DCON	Type
3331020	10,2	48	46	90	10	2
3331030	10,3	48	46	90	10	2
3331040	10,4	48	46	90	10	2
3331050	10,5	48	46	90	10	2
3331060	10,6	48	46	90	10	2
3331070	10,7	48	46	90	10	2
3331080	10,8	48	46	90	10	2
3331090	10,9	48	46	90	10	2
3331100	11	48	46	90	10	2
3331103	11,03	52	50	95	10	2
3331110	11,1	52	50	95	10	2
3331120	11,2	52	50	95	10	2
3331130	11,3	52	50	95	10	2
3331140	11,4	52	50	95	10	2
3331150	11,5	52	50	95	10	2
3331160	11,6	52	50	95	10	2
3331170	11,7	52	50	95	10	2
3331180	11,8	52	50	95	10	2
3331190	11,9	52	50	95	10	2
3331200	12	52	50	95	12	2
3331203	12,03	58	56	100	12	2
3331210	12,1	58	56	100	12	2
3331220	12,2	58	56	100	12	2
3331230	12,3	58	56	100	12	2
3331240	12,4	58	56	100	12	2
3331250	12,5	58	56	100	12	2
3331260	12,6	58	56	100	12	2
3331270	12,7	58	56	100	12	2
3331280	12,8	58	56	100	12	2
3331290	12,9	58	56	100	12	2
3331300	13	58	56	100	12	2
3331310	13,1	62	60	105	12	2
3331320	13,2	62	60	105	12	2
3331330	13,3	62	60	105	12	2
3331340	13,4	62	60	105	12	2
3331350	13,5	62	60	105	12	2
3331360	13,6	62	60	105	12	2
3331370	13,7	62	60	105	12	2
3331380	13,8	62	60	105	12	2
3331390	13,9	62	60	105	12	2
3331400	14	62	60	105	12	2
3331410	14,1	66	64	110	12	2
3331420	14,2	66	64	110	12	2
3331430	14,3	66	64	110	12	2
3331440	14,4	66	64	110	12	2
3331450	14,5	66	64	110	12	2

EDP	DC	LU	LCF	OAL	DCON	Type
3331460	14,6	66	64	110	12	2
3331470	14,7	66	64	110	12	2
3331480	14,8	66	64	110	12	2
3331490	14,9	66	64	110	12	2
3331500	15	66	64	110	12	2
3331510	15,1	70	68	115	12	2
3331520	15,2	70	68	115	12	2
3331530	15,3	70	68	115	12	2
3331540	15,4	70	68	115	12	2
3331550	15,5	70	68	115	12	2
3331560	15,6	70	68	115	12	2
3331570	15,7	70	68	115	12	2
3331580	15,8	70	68	115	12	2
3331590	15,9	70	68	115	12	2
3331600	16	70	68	115	16	2
3331650	16,5	76	74	125	16	2
3331700	17	76	74	125	16	2
3331750	17,5	80	78	130	16	2
3331800	18	80	78	130	16	2
3331850	18,5	86	84	135	16	2
3331900	19	86	84	135	16	2
3331950	19,5	90	88	140	16	2
3332000	20	90	88	140	20	2

ADFLS-2D

Drilling | Solid carbide | Flat drills

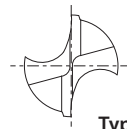

Type 1

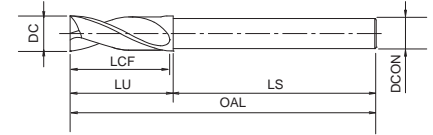
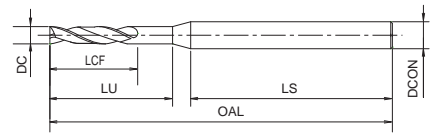

Type 2

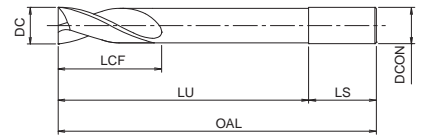

Type 3

- First choice in quality and performance
- Carbide drill with EgiAs coating
- Up to 2xD
- For deep reach flat drilling application
- 78 sizes



EDP	DC	LU	LCF	OAL	DCON	Type
3332300	3	30	15	100	6	1
3332310	3,1	31	15	100	6	1
3332320	3,2	32	15	100	6	1
3332330	3,3	33	15	100	6	1
3332340	3,4	34	16	100	6	1
3332350	3,5	35	16	100	6	1
3332360	3,6	36	16	100	6	1
3332370	3,7	37	16	100	6	1
3332380	3,8	38	19	100	6	1
3332390	3,9	39	19	100	6	1
3332400	4	40	19	100	6	1
3332410	4,1	41	19	100	6	1
3332420	4,2	42	21	100	6	1
3332430	4,3	43	21	100	6	1
3332440	4,4	44	21	100	6	1
3332450	4,5	45	21	100	6	1
3332460	4,6	46	21	100	6	1
3332470	4,7	47	21	100	6	1
3332480	4,8	48	24	100	6	1
3332490	4,9	49	24	100	6	1
3332500	5	50	24	110	6	1
3332510	5,1	51	24	110	6	1
3332520	5,2	52	24	110	6	1
3332530	5,3	53	24	110	6	1
3332540	5,4	54	27	110	6	1
3332550	5,5	55	27	110	6	1
3332560	5,6	56	27	110	6	1
3332570	5,7	57	27	110	6	1
3332580	5,8	58	27	110	6	1
3332590	5,9	59	27	110	6	1
3332600	6	29	27	110	6	2
3334060	6	60	27	110	6	3
3332650	6,5	32	30	120	6	2
3332680	6,8	32	30	120	6	2
3332690	6,9	32	30	120	6	2
3332700	7	32	30	120	6	2
3332740	7,4	36	34	130	6	2
3332750	7,5	36	34	130	6	2
3332780	7,8	36	34	130	6	2
3332800	8	36	34	130	8	2
3334080	8	80	34	130	8	3
3332850	8,5	40	38	140	8	2
3332860	8,6	40	38	140	8	2
3332880	8,8	40	38	140	8	2
3332900	9	40	38	140	8	2
3332920	9,2	44	42	150	8	2

EDP	DC	LU	LCF	OAL	DCON	Type
3332950	9,5	44	42	150	8	2
3332980	9,8	44	42	150	8	2
3333000	10	44	42	150	10	2
3334100	10	100	42	150	10	3
3333030	10,3	48	46	160	10	2
3333040	10,4	48	46	160	10	2
3333050	10,5	48	46	160	10	2
3333080	10,8	48	46	160	10	2
3333100	11	48	46	160	10	2
3333110	11,1	52	50	170	10	2
3333150	11,5	52	50	170	10	2
3333180	11,8	52	50	170	10	2
3333200	12	52	50	170	12	2
3334120	12	120	50	170	12	3
3333250	12,5	58	56	180	12	2
3333300	13	58	56	180	12	2
3333350	13,5	62	60	190	12	2
3333400	14	62	60	190	12	2
3333450	14,5	66	64	200	12	2
3333500	15	66	64	200	12	2
3333550	15,5	70	68	210	12	2
3333600	16	70	68	210	16	2
3334160	16	160	68	210	16	3
3333650	16,5	76	74	220	16	2
3333700	17	76	74	220	16	2
3333750	17,5	80	78	230	16	2
3333800	18	80	78	230	16	2
3333850	18,5	86	84	240	16	2
3333900	19	86	84	240	16	2
3333950	19,5	90	88	250	16	2
3334000	20	90	88	250	20	2
3334200	20	200	88	250	20	3

ADFO-3D

Drilling | Solid carbide | Flat drills

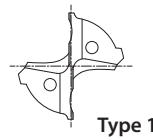

Type 1

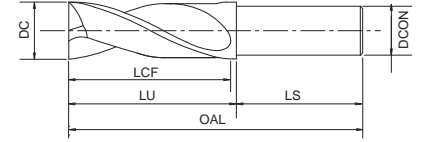
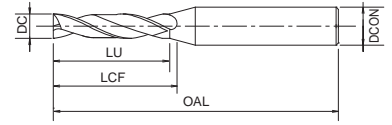

Type 2

- First choice in quality and performance
- Carbide drill with internal coolant, EgiAs coating
- Up to 3xD
- Flat drilling application
- 160 sizes



Drilling | Solid carbide

Flat drills

EDP	DC	LU	LCF	OAL	DCON	Type
3334300	3	15	16	55	4	1
3334301	3,03	15	16	55	4	1
3334302	3,1	15	16	55	4	1
3334303	3,15	15	16	55	4	1
3334304	3,2	15	16	55	4	1
3334305	3,3	15	16	55	4	1
3334306	3,4	16	17	55	4	1
3334307	3,5	16	17	55	4	1
3334308	3,53	16	17	55	4	1
3334309	3,6	16	17	55	4	1
3334310	3,66	16	17	55	4	1
3334311	3,68	16	17	55	4	1
3334312	3,7	16	17	55	4	1
3334313	3,8	19	20	60	4	1
3334314	3,9	19	20	60	4	1
3334315	4	19	20	60	4	2
3334316	4,03	21	22	60	6	1
3334317	4,1	21	22	60	6	1
3334318	4,2	21	22	60	6	1
3334319	4,3	21	22	60	6	1
3334320	4,4	21	22	60	6	1
3334321	4,5	21	22	60	6	1
3334322	4,53	21	21	60	6	1
3334323	4,6	21	21	60	6	1
3334324	4,62	21	21	60	6	1
3334325	4,64	21	21	60	6	1
3334326	4,7	21	21	60	6	1
3334327	4,8	24	24	65	6	1
3334328	4,9	24	24	65	6	1
3334329	5	24	24	65	6	1
3334330	5,03	24	24	65	6	1
3334331	5,1	24	24	65	6	1
3334332	5,2	24	24	65	6	1
3334333	5,3	24	24	65	6	1
3334334	5,4	27	27	65	6	1
3334335	5,5	27	27	65	6	1
3334336	5,52	27	27	65	6	1
3334337	5,54	27	27	65	6	1
3334338	5,6	27	27	65	6	1
3334339	5,7	27	27	65	6	1
3334340	5,8	27	27	65	6	1
3334341	5,9	27	27	65	6	1
3334342	6	27	27	65	6	2
3334343	6,03	30	30	70	8	1
3334344	6,1	30	30	70	8	1
3334345	6,2	30	31	70	8	1

EDP	DC	LU	LCF	OAL	DCON	Type
3334346	6,3	30	31	70	8	1
3334347	6,4	30	31	70	8	1
3334348	6,5	30	31	70	8	1
3334349	6,53	30	31	70	8	1
3334350	6,6	30	31	70	8	1
3334351	6,7	30	31	70	8	1
3334352	6,8	30	31	70	8	1
3334353	6,9	30	31	70	8	1
3334354	7	30	31	70	8	1
3334355	7,03	30	31	70	8	1
3334356	7,1	34	35	75	8	1
3334357	7,2	34	35	75	8	1
3334358	7,3	34	35	75	8	1
3334359	7,4	34	35	75	8	1
3334360	7,5	34	35	75	8	1
3334361	7,6	34	35	75	8	1
3334362	7,7	34	35	75	8	1
3334363	7,8	34	35	75	8	1
3334364	7,9	34	35	75	8	1
3334365	8	34	35	75	8	2
3334366	8,03	38	39	80	10	1
3334367	8,1	38	39	80	10	1
3334368	8,2	38	39	80	10	1
3334369	8,3	38	39	80	10	1
3334370	8,4	38	39	80	10	1
3334371	8,5	38	39	80	10	1
3334372	8,53	38	39	80	10	1
3334373	8,6	38	39	80	10	1
3334374	8,7	38	39	80	10	1
3334375	8,8	38	39	80	10	1
3334376	8,9	38	39	80	10	1
3334377	9	38	39	80	10	1
3334378	9,03	38	39	80	10	1
3334379	9,1	42	43	85	10	1
3334380	9,2	42	43	85	10	1
3334381	9,3	42	43	85	10	1
3334382	9,4	42	43	85	10	1
3334383	9,5	42	43	85	10	1
3334384	9,6	42	43	85	10	1
3334385	9,7	42	43	85	10	1
3334386	9,8	42	43	85	10	1
3334387	9,9	42	43	85	10	1
3334388	10	42	43	85	10	2
3334389	10,03	46	47	90	12	1
3334390	10,1	46	47	90	12	1
3334391	10,2	46	47	90	12	1

ADFO-3D

Drilling | Solid carbide | Flat drills

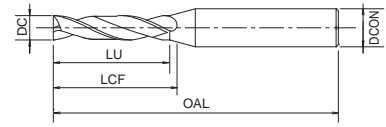
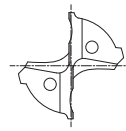

Type 1

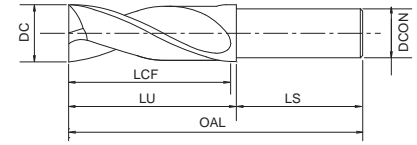

Type 2

- First choice in quality and performance
- Carbide drill with internal coolant, EgiAs coating
- Up to 3xD
- Flat drilling application
- 160 sizes



EDP	DC	LU	LCF	OAL	DCON	Type
3334392	10,3	46	47	90	12	1
3334393	10,4	46	47	90	12	1
3334394	10,5	46	47	90	12	1
3334395	10,6	46	47	90	12	1
3334396	10,7	46	47	90	12	1
3334397	10,8	46	47	90	12	1
3334398	10,9	46	47	90	12	1
3334399	11	46	47	90	12	1
3334400	11,03	46	47	90	12	1
3334401	11,1	50	51	95	12	1
3334402	11,2	50	51	95	12	1
3334403	11,3	50	51	95	12	1
3334404	11,4	50	51	95	12	1
3334405	11,5	50	51	95	12	1
3334406	11,6	50	51	95	12	1
3334407	11,7	50	51	95	12	1
3334408	11,8	50	51	95	12	1
3334409	11,9	50	51	95	12	1
3334410	12	50	51	95	12	2
3334411	12,03	56	57	100	14	1
3334412	12,1	56	57	100	14	1
3334413	12,2	56	57	100	14	1
3334414	12,3	56	57	100	14	1
3334415	12,4	56	57	100	14	1
3334416	12,5	56	57	100	14	1
3334417	12,6	56	57	100	14	1
3334418	12,7	56	57	100	14	1
3334419	12,8	56	57	100	14	1
3334420	12,9	56	57	100	14	1
3334421	13	56	57	100	14	1
3334422	13,1	60	61	105	14	1
3334423	13,2	60	61	105	14	1
3334424	13,3	60	61	105	14	1
3334425	13,4	60	61	105	14	1
3334426	13,5	60	61	105	14	1
3334427	13,6	60	61	105	14	1
3334428	13,7	60	61	105	14	1
3334429	13,8	60	61	105	14	1
3334430	13,9	60	61	105	14	1
3334431	14	60	61	105	14	2
3334432	14,1	64	65	110	16	1
3334433	14,2	64	65	110	16	1
3334434	14,3	64	65	110	16	1
3334435	14,4	64	65	110	16	1
3334436	14,5	64	65	110	16	1
3334437	14,6	65	65	110	16	1

EDP	DC	LU	LCF	OAL	DCON	Type
3334438	14,7	65	65	110	16	1
3334439	14,8	65	65	110	16	1
3334440	14,9	65	65	110	16	1
3334441	15	65	65	110	16	1
3334442	15,1	69	69	115	16	1
3334443	15,2	69	69	115	16	1
3334444	15,3	69	69	115	16	1
3334445	15,4	69	69	115	16	1
3334446	15,5	69	69	115	16	1
3334447	15,6	69	69	115	16	1
3334448	15,7	69	69	115	16	1
3334449	15,8	69	69	115	16	1
3334450	15,9	69	69	115	16	1
3334451	16	69	69	115	16	2
3334452	16,5	75	75	125	18	1
3334453	17	75	75	125	18	1
3334454	17,5	79	79	130	18	1
3334455	18	79	79	130	18	2
3334456	18,5	85	85	135	20	1
3334457	19	85	85	135	20	1
3334458	19,5	88	89	140	20	1
3334459	20	88	89	140	20	2

CUTTING CONDITIONS

Drilling | Solid | Cutting conditions

ADF-2D

Vc	Low Carbon Steel - Alloy Steel (C<0.3%) SS400 • SCM ~710N/mm ²		Carbon Steel S35C • S50C ~210HB ~710N/mm ²		Alloy Steel SCM • SCr • SNCM 28~35HRC 900~1,100N/mm ²		Plastic Mold Steel NAK80 ~40HRC		Stainless Steel SUS304 480 ~ 800N/mm ²	
	Speed (min ⁻¹)	Feed Rate (mm/rev.)	Speed (min ⁻¹)	Feed Rate (mm/rev.)	Speed (min ⁻¹)	Feed Rate (mm/rev.)	Speed (min ⁻¹)	Feed Rate (mm/rev.)	Speed (min ⁻¹)	Feed Rate (mm/rev.)
0.2	40.000	0.001 ~ 0.006	40.000	0.001 ~ 0.006	40.000	0.001 ~ 0.006	40.000	0.001 ~ 0.004	40.000	0.001 ~ 0.004
0.5	28.700	0.003 ~ 0.015	28.700	0.003 ~ 0.015	25.500	0.003 ~ 0.015	19.000	0.003 ~ 0.01	15.900	0.003 ~ 0.01
1	17.500	0.005 ~ 0.03	17.500	0.005 ~ 0.03	15.900	0.005 ~ 0.03	9.550	0.005 ~ 0.02	8.000	0.005 ~ 0.02
1.5	13.800	0.008 ~ 0.045	13.800	0.008 ~ 0.045	12.700	0.008 ~ 0.045	6.350	0.008 ~ 0.03	5.300	0.008 ~ 0.03
2	12.700	0.01 ~ 0.06	12.700	0.01 ~ 0.06	9.550	0.01 ~ 0.06	4.750	0.01 ~ 0.04	-	-
3	8.500	0.015 ~ 0.09	8.500	0.015 ~ 0.09	6.350	0.015 ~ 0.09	3.200	0.015 ~ 0.06	-	-
4	6.350	0.02 ~ 0.12	6.350	0.02 ~ 0.12	4.750	0.02 ~ 0.12	2.400	0.02 ~ 0.08	-	-
6	4.250	0.03 ~ 0.18	4.250	0.03 ~ 0.18	3.200	0.03 ~ 0.18	1.600	0.03 ~ 0.12	-	-
8	3.200	0.04 ~ 0.24	3.200	0.04 ~ 0.24	2.400	0.04 ~ 0.24	1.200	0.04 ~ 0.16	-	-
10	2.550	0.05 ~ 0.3	2.550	0.05 ~ 0.3	1.900	0.05 ~ 0.3	950	0.05 ~ 0.2	-	-
12	2.100	0.06 ~ 0.3	2.100	0.06 ~ 0.3	1.600	0.06 ~ 0.3	800	0.06 ~ 0.24	-	-
14	1.800	0.07 ~ 0.35	1.800	0.07 ~ 0.35	1.350	0.07 ~ 0.35	700	0.07 ~ 0.28	-	-
16	1.600	0.08 ~ 0.36	1.600	0.08 ~ 0.36	1.200	0.08 ~ 0.36	600	0.08 ~ 0.32	-	-
18	1.400	0.09 ~ 0.38	1.400	0.09 ~ 0.38	1.050	0.09 ~ 0.38	550	0.09 ~ 0.36	-	-
20	1.250	0.1 ~ 0.4	1.250	0.1 ~ 0.4	950	0.1 ~ 0.4	500	0.1 ~ 0.4	-	-

Vc	Special Alloy Steel - Hardened Steel - Pre-hardened Steel FC250 ~45HRC		Cast Iron FC250 ~350N/mm ²		Ductile Cast Iron FCD600 400 ~ 600N/mm ²		Aluminium A5052 • A7075 ~350N/mm ²		Aluminium Alloy AC4C • ADC 400~600N/mm ²	
	Speed (min ⁻¹)	Feed Rate (mm/rev.)	Speed (min ⁻¹)	Feed Rate (mm/rev.)	Speed (min ⁻¹)	Feed Rate (mm/rev.)	Speed (min ⁻¹)	Feed Rate (mm/rev.)	Speed (min ⁻¹)	Feed Rate (mm/rev.)
0.2	40.000	0.001 ~ 0.004	40.000	0.001 ~ 0.006	40.000	0.001 ~ 0.006	40.000	0.001 ~ 0.006	40.000	0.001 ~ 0.006
0.5	15.900	0.003 ~ 0.01	32.000	0.003 ~ 0.015	25.000	0.003 ~ 0.015	35.000	0.003 ~ 0.015	35.000	0.003 ~ 0.015
1	7.950	0.005 ~ 0.02	22.500	0.005 ~ 0.03	15.900	0.005 ~ 0.03	30.000	0.005 ~ 0.03	30.000	0.005 ~ 0.03
1.5	5.300	0.008 ~ 0.03	17.000	0.008 ~ 0.045	11.500	0.008 ~ 0.045	25.000	0.008 ~ 0.045	25.000	0.008 ~ 0.045
2	4.000	0.01 ~ 0.03	14.300	0.01 ~ 0.06	10.350	0.01 ~ 0.06	22.300	0.01 ~ 0.06	22.300	0.01 ~ 0.06
3	2.650	0.015 ~ 0.045	9.550	0.015 ~ 0.09	6.900	0.015 ~ 0.09	14.850	0.015 ~ 0.09	14.850	0.015 ~ 0.09
4	2.000	0.02 ~ 0.06	7.150	0.02 ~ 0.12	5.150	0.02 ~ 0.12	11.150	0.02 ~ 0.12	11.150	0.02 ~ 0.12
6	1.350	0.03 ~ 0.09	4.750	0.03 ~ 0.18	3.450	0.03 ~ 0.18	7.450	0.03 ~ 0.18	7.450	0.03 ~ 0.18
8	1.000	0.04 ~ 0.12	3.600	0.04 ~ 0.24	2.600	0.04 ~ 0.24	5.550	0.04 ~ 0.24	5.550	0.04 ~ 0.24
10	800	0.05 ~ 0.15	2.850	0.05 ~ 0.3	2.050	0.05 ~ 0.3	4.450	0.05 ~ 0.3	4.450	0.05 ~ 0.3
12	650	0.06 ~ 0.18	2.400	0.06 ~ 0.3	1.700	0.06 ~ 0.3	3.700	0.06 ~ 0.36	3.700	0.06 ~ 0.36
14	550	0.07 ~ 0.21	2.050	0.07 ~ 0.35	1.500	0.07 ~ 0.35	3.200	0.07 ~ 0.42	3.200	0.07 ~ 0.42
16	500	0.08 ~ 0.24	1.800	0.08 ~ 0.36	1.300	0.08 ~ 0.36	2.800	0.08 ~ 0.48	2.800	0.08 ~ 0.48
18	450	0.09 ~ 0.27	1.600	0.09 ~ 0.38	1.150	0.09 ~ 0.38	2.500	0.09 ~ 0.54	2.500	0.09 ~ 0.54
20	400	0.1 ~ 0.3	1.450	0.1 ~ 0.4	1.050	0.1 ~ 0.4	2.250	0.1 ~ 0.6	2.250	0.1 ~ 0.6

ADFLS-2D

Vc	Low Carbon Steel - Alloy Steel (C<0.3%) SS400 • SCM ~710N/mm ²		Carbon Steel S35C • S50C ~210HB ~710N/mm ²		Alloy Steel SCM • SCr • SNCM 28~35HRC 900~1,100N/mm ²		Plastic Mold Steel NAK80 ~40HRC		Special Alloy Steel - Hardened Steel - Pre-hardened steel SKD61 ~50HRC	
	Speed (min ⁻¹)	Feed Rate (mm/rev.)	Speed (min ⁻¹)	Feed Rate (mm/rev.)	Speed (min ⁻¹)	Feed Rate (mm/rev.)	Speed (min ⁻¹)	Feed Rate (mm/rev.)	Speed (min ⁻¹)	Feed Rate (mm/rev.)
3	8.500	0.045 ~ 0.075	8.500	0.045 ~ 0.075	6.350	0.045 ~ 0.075	3.200	0.045 ~ 0.06	2.650	0.03 ~ 0.06
4	6.350	0.06 ~ 0.1	6.350	0.06 ~ 0.1	4.750	0.06 ~ 0.1	2.400	0.06 ~ 0.08	2.000	0.04 ~ 0.08
6	4.250	0.09 ~ 0.15	4.250	0.09 ~ 0.15	3.200	0.09 ~ 0.15	1.600	0.09 ~ 0.12	1.350	0.06 ~ 0.12
8	3.200	0.12 ~ 0.2	3.200	0.12 ~ 0.2	2.400	0.12 ~ 0.2	1.200	0.12 ~ 0.16	1.000	0.08 ~ 0.16
10	2.550	0.15 ~ 0.25	2.550	0.15 ~ 0.25	1.900	0.15 ~ 0.25	950	0.15 ~ 0.2	800	0.1 ~ 0.2
12	2.100	0.18 ~ 0.3	2.100	0.18 ~ 0.3	1.600	0.18 ~ 0.3	800	0.18 ~ 0.24	650	0.12 ~ 0.24
14	1.800	0.21 ~ 0.35	1.800	0.21 ~ 0.35	900	0.21 ~ 0.35	700	0.21 ~ 0.28	550	0.14 ~ 0.28
16	1.600	0.24 ~ 0.4	1.600	0.24 ~ 0.4	800	0.24 ~ 0.4	600	0.24 ~ 0.32	500	0.16 ~ 0.32
18	1.400	0.27 ~ 0.45	1.400	0.27 ~ 0.45	700	0.27 ~ 0.45	550	0.27 ~ 0.36	450	0.18 ~ 0.36
20	1.250	0.3 ~ 0.5	1.250	0.3 ~ 0.5	650	0.3 ~ 0.5	500	0.3 ~ 0.4	400	0.2 ~ 0.4

Vc	Cast Iron FC250 ~350N/mm ²		Ductile Cast Iron FCD600 400 ~ 600N/mm ²		Aluminium A5052 • A7075 ~350N/mm ²		Aluminium Alloy AC4C • ADC 400~600N/mm ²	
	Speed (min ⁻¹)	Feed Rate (mm/rev.)	Speed (min ⁻¹)	Feed Rate (mm/rev.)	Speed (min ⁻¹)	Feed Rate (mm/rev.)	Speed (min ⁻¹)	Feed Rate (mm/rev.)
3	9.550	0.06 ~ 0.09	6.900	0.06 ~ 0.09	14.850	0.015 ~ 0.09	14.850	0.015 ~ 0.09
4	7.150	0.08 ~ 0.12	5.150	0.08 ~ 0.12	11.150	0.02 ~ 0.12	11.150	0.02 ~ 0.12
6	4.750	0.12 ~ 0.18	3.450	0.12 ~ 0.18	7.450	0.03 ~ 0.18	7.450	0.03 ~ 0.18
8	3.600	0.16 ~ 0.24	2.600	0.16 ~ 0.24	5.550	0.04 ~ 0.24	5.550	0.04 ~ 0.24
10	2.850	0.2 ~ 0.3	2.050	0.2 ~ 0.3	4.450	0.05 ~ 0.3	4.450	0.05 ~ 0.3
12	2.400	0.24 ~ 0.36	1.700	0.24 ~ 0.36	3.700	0.06 ~ 0.36	3.700	0.06 ~ 0.36
14	2.050	0.28 ~ 0.42	1.500	0.28 ~ 0.42	3.200	0.07 ~ 0.42	3.200	0.07 ~ 0.42
16	1.800	0.32 ~ 0.48	1.300	0.32 ~ 0.48	2.800	0.08 ~ 0.48	2.800	0.08 ~ 0.48
18	1.600	0.36 ~ 0.54	1.150	0.36 ~ 0.54	2.500	0.09 ~ 0.54	2.500	0.09 ~ 0.54
20	1.450	0.4 ~ 0.6	1.050	0.4 ~ 0.6	2.250	0.1 ~ 0.6	2.250	0.1 ~ 0.6

- To process flat surfaces, prior Centre-drilling with a larger diameter is required.
- Water-soluble coolant may be applied as noted in the above table only under the premise that the work surface has been flattened by milling.
- When using non-water soluble oil or water-emulsifiable (over 20 times dilution), reduce cutting speed by 30%.
- Use a rigid and precise machine and holder.
- Please minimize tool hang over as much as possible during machining.
- Adjust the rotational speed and the feed rate in accordance with conditions such as the machining shape, machine rigidity, or work holding.
- Please set up the drill so that the runout of the cutting edge is under 0.01 mm.
- When machining an inclined plane, adjust the rotational speed and the feed rate in accordance with the angle of the incline (β).
 - When the machining incline angle(β) is less than 30°, please reduce the feed to 40~60%.
 - When the machining incline angle(β) is over 30°, please reduce the speed to 60~80%, the feed to 20~40%.
- Please use step drilling in pilot holes to improve cutting chip separation.
- If it is necessary to ensure the locating precision of the hole to be machined, adjust the rotational speed and the feed rate as indicated above (in accordance with the machining precision requirement).

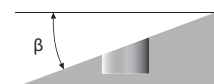

Drilling | Solid carbide

Cutting conditions

CUTTING CONDITIONS

Drilling | Solid | Cutting conditions

ADFO-3D

Vc	Low Carbon Steel - Alloy Steel (C<0.3%) SS400 • SCM ~710N/mm ²		Carbon Steel S35C • S50C ~210HB ~710N/mm ²		Alloy Steel SCM • SCr • SNCM 28~35HRC 900~1,100N/mm ²		Plastic Mold Steel NAK80 ~40HRC		Stainless Steel SUS304 480~800N/mm ²	
	80~120m/min		80~120m/min		50~90m/min		20~40m/min		40~60m/min	
Ø	Speed (min ⁻¹)	Feed Rate (mm/rev.)	Speed (min ⁻¹)	Feed Rate (mm/rev.)	Speed (min ⁻¹)	Feed Rate (mm/rev.)	Speed (min ⁻¹)	Feed Rate (mm/rev.)	Speed (min ⁻¹)	Feed Rate (mm/rev.)
3	10.600	0,045 ~ 0,09	10.600	0,045 ~ 0,09	7.450	0,045 ~ 0,09	3.200	0,045 ~ 0,09	5.300	0,045 ~ 0,09
4	8.000	0,045 ~ 0,12	8.000	0,045 ~ 0,12	5.550	0,045 ~ 0,12	2.400	0,045 ~ 0,12	4.000	0,045 ~ 0,12
6	5.300	0,06 ~ 0,18	5.300	0,06 ~ 0,18	3.700	0,06 ~ 0,18	1.600	0,06 ~ 0,18	2.650	0,06 ~ 0,18
8	4.000	0,08 ~ 0,24	4.000	0,08 ~ 0,24	2.800	0,08 ~ 0,24	1.200	0,08 ~ 0,24	2.000	0,08 ~ 0,24
10	3.200	0,10 ~ 0,30	3.200	0,10 ~ 0,30	2.250	0,10 ~ 0,30	950	0,10 ~ 0,30	1.600	0,10 ~ 0,30
12	2.650	0,12 ~ 0,36	2.650	0,12 ~ 0,36	1.850	0,12 ~ 0,36	800	0,12 ~ 0,36	1.350	0,12 ~ 0,36
14	2.250	0,14 ~ 0,42	2.250	0,14 ~ 0,42	1.600	0,14 ~ 0,42	700	0,14 ~ 0,42	1.150	0,14 ~ 0,42
16	2.000	0,16 ~ 0,48	2.000	0,16 ~ 0,48	1.400	0,16 ~ 0,48	600	0,16 ~ 0,48	1.000	0,16 ~ 0,48
18	1.750	0,18 ~ 0,54	1.750	0,18 ~ 0,54	1.250	0,18 ~ 0,54	550	0,18 ~ 0,54	900	0,18 ~ 0,54
20	1.600	0,20 ~ 0,60	1.600	0,20 ~ 0,60	1.100	0,20 ~ 0,60	500	0,20 ~ 0,60	800	0,20 ~ 0,60

Vc	Cast Iron FC250 ~350N/mm ²		Ductile Cast Iron FCD600 400 ~600N/mm ²		Aluminium A5052 • A7075 ~350N/mm ²		Aluminium Alloy AC4C • ADC 400~600N/mm ²	
	80~120m/min		60~100m/min		120~200m/min		120~200m/min	
Ø	Speed (min ⁻¹)	Feed Rate (mm/rev.)	Speed (min ⁻¹)	Feed Rate (mm/rev.)	Speed (min ⁻¹)	Feed Rate (mm/rev.)	Speed (min ⁻¹)	Feed Rate (mm/rev.)
3	10.600	0,045 ~ 0,09	8.500	0,045 ~ 0,09	17.000	0,045 ~ 0,09	17.000	0,045 ~ 0,09
4	8.000	0,045 ~ 0,12	6.350	0,045 ~ 0,12	12.750	0,045 ~ 0,12	12.750	0,045 ~ 0,12
6	5.300	0,06 ~ 0,18	4.250	0,06 ~ 0,18	8.500	0,06 ~ 0,18	8.500	0,06 ~ 0,18
8	4.000	0,08 ~ 0,24	3.200	0,08 ~ 0,24	6.350	0,08 ~ 0,24	6.350	0,08 ~ 0,24
10	3.200	0,10 ~ 0,30	2.550	0,10 ~ 0,30	5.100	0,10 ~ 0,30	5.100	0,10 ~ 0,30
12	2.650	0,12 ~ 0,36	2.100	0,12 ~ 0,36	4.250	0,12 ~ 0,36	4.250	0,12 ~ 0,36
14	2.250	0,14 ~ 0,42	1.800	0,14 ~ 0,42	3.650	0,14 ~ 0,42	3.650	0,14 ~ 0,42
16	2.000	0,16 ~ 0,48	1.600	0,16 ~ 0,48	3.200	0,16 ~ 0,48	3.200	0,16 ~ 0,48
18	1.750	0,18 ~ 0,54	1.400	0,18 ~ 0,54	2.850	0,18 ~ 0,54	2.850	0,18 ~ 0,54
20	1.600	0,20 ~ 0,60	1.250	0,20 ~ 0,60	2.550	0,20 ~ 0,60	2.550	0,20 ~ 0,60

- Water-soluble coolant may be applied as noted in the above table only under the premise that the work surface has been flattened by milling.
- Use a rigid and precise machine and holder.
- Please minimize overhang length as much as possible during machining.
- Adjust the rotational speed and the feed in accordance with conditions such as the machining shape, machine rigidity, or work holding.
- Please set up the drill so that the runout of the cutting edge is under 0.02 mm.
- Please select a cutting fluid that is most suitable for the work material with minimal smoke formation.
- In the case of dry machining, please use air blow to remove chips to prevent clogging.
Please do not machine stainless steel dry.
- When machining an inclined plane, adjust the rotational speed and the feed in accordance with the angle of the incline (β).
When the machining incline angle (β) is less than 30°, please reduce the feed to 40-60%.
When the machining incline angle (β) is over 30°, please reduce the speed to 60-80%, the feed to 20-40%.
- Please use step drilling in pilot holes to improve cutting chip separation.
- If it is necessary to ensure the locating precision of the hole to be machined, adjust the rotational speed and the feed as indicated above (in accordance with the machining precision requirement).
- Please always use the appropriate cutting fluid recommended by the cutting fluid manufacturer in the machining of magnesium alloys. Be cautious with the cutting chips as they are highly flammable and may pose a serious fire risk if not properly handled.

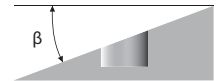

Machining Tips

Taps and drill combination

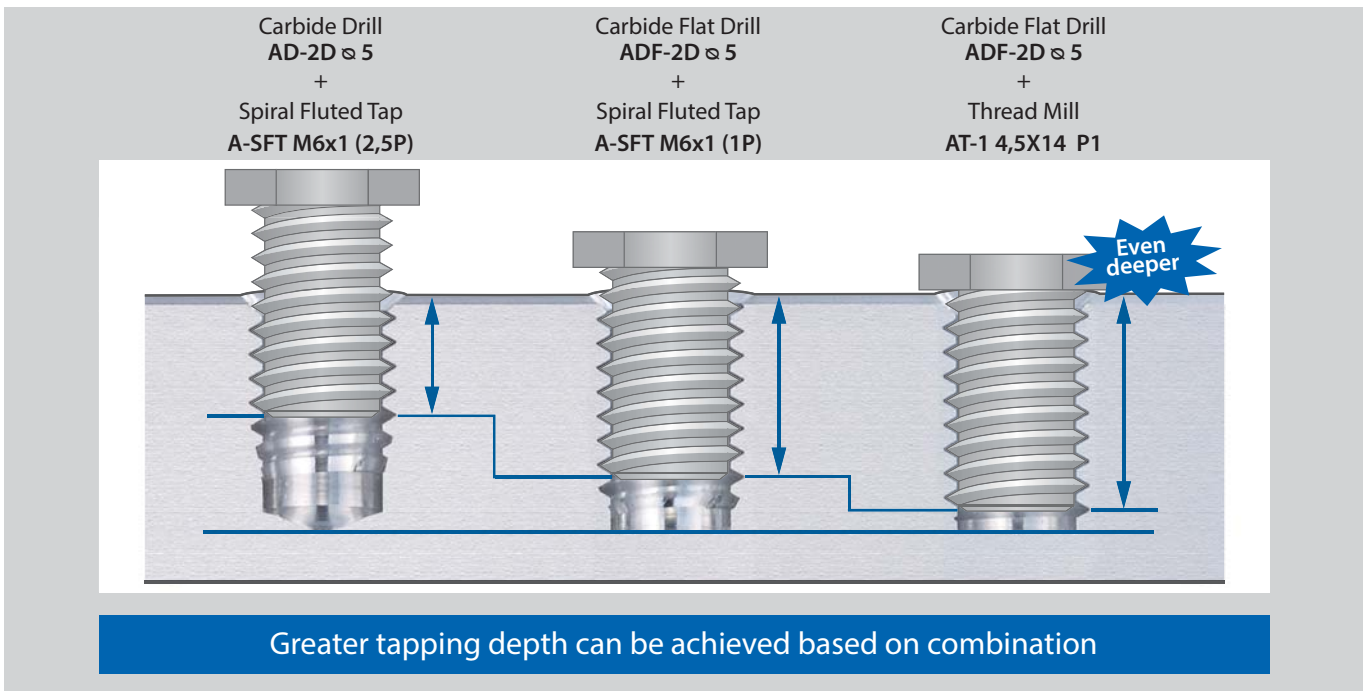

Drilling before tapping process

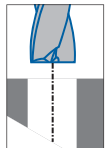

Machining	Drilling		Tapping
Tool	ADF-2D ø 8,5	Competitor's general carbide drill	A-POT M10x1,5
Machined Surface	Flat Surface	inclined surface (30°)	
Work Material	SS400		
Cutting Speed	50m/min (1.873 min ⁻¹)		30m/min (995 min ⁻¹)
Feed Rate	318 mm/min (0,17 mm/rev)		-
Depth of Hole	20 mm (Through)		
Coolant	Water soluble		
Machine	Horizontal Synchronized Machining Center		

Counterboring

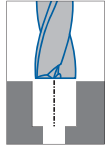

Tool	ADF-2D Ø18
Machined Surface	Flat Surface
Work Material	FC250
Cutting Speed	75m/min (1.327 min ⁻¹)
Feed Rate	133 mm/min (0,1 mm/rev)
Depth of Hole	34 mm (blind)
Coolant	Water soluble
Machine	Horizontal Machining Center

■ Shift length in hole position

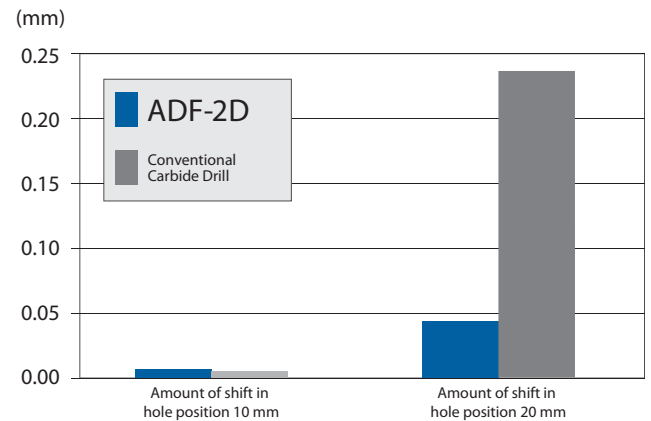
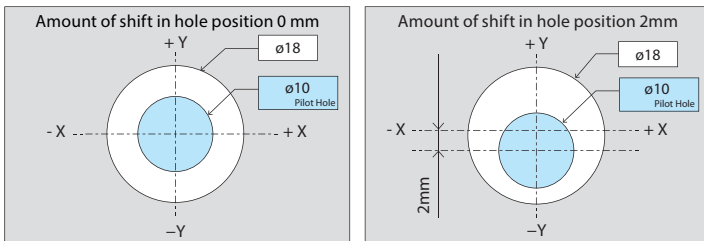

Through-hole in curved surface

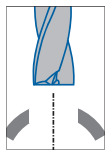

Tool	ADF-2D Ø6
Machined Surface	Flat Surface - Curved Surface
Work Material	S50C
Cutting Speed	75m/min (3.981 min ⁻¹)
Feed Rate	398 mm/min (0,1 mm/rev)
Depth of Hole	15 mm (Through)
Coolant	Water Soluble
Machine	Horizontal Machining Center

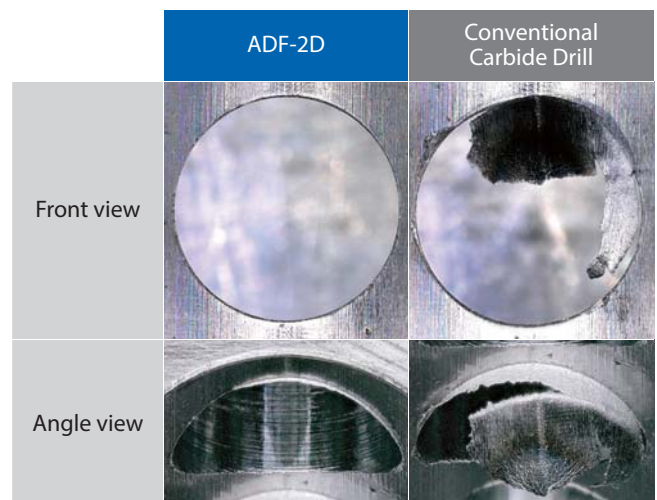

Half-hole

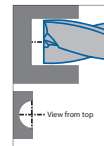

Tool	ADF-2D Ø12
Machined surface	Flat Surface
Work Material	S50C
Cutting Speed	37m/min (982 min ⁻¹)
Feed Rate	157 mm/min (0,16 mm/rev)
Depth of Hole	24 mm (Blind)
Coolant	Water Soluble
Machine	Horizontal Machining Center

Drilling | Solid carbide

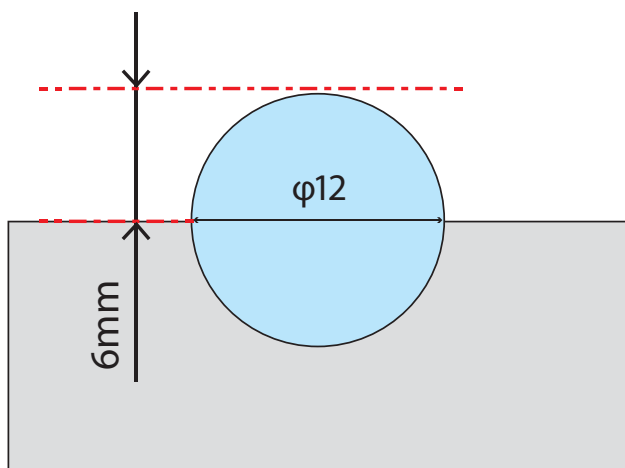

■ Fallen amount (based on the value of 1mm for hole entry)

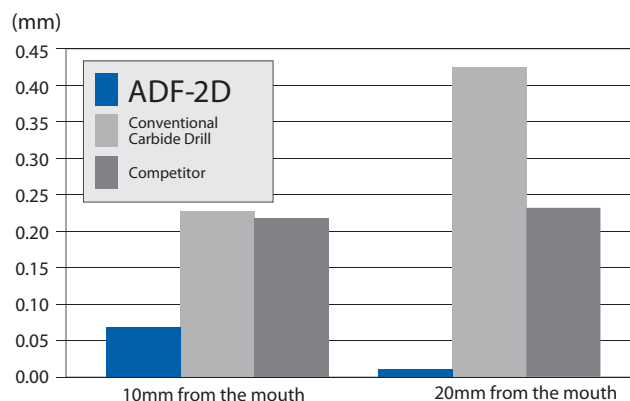

Small diameter flat surface processing

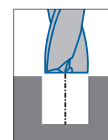

Machining Data

Tool	ADF-2D Ø0,2
Machined Surface	Flat Surface
Work Material	SUS304
Cutting Speed	25m/min (38,788 min ⁻¹)
Feed Rate	58 mm/min (0,0015 mm/rev)
Depth of Hole	0,4 mm (Blind)
Coolant	Water Soluble
Machine	Vertical Machining Center (HSK E25)

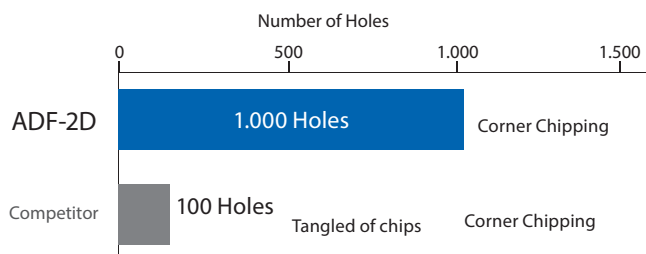

■ Comparison after processing 100 holes

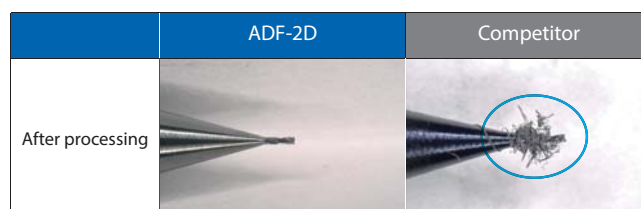

Flat surface

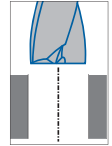

Tool	ADF-2D Ø10
Machined Surface	Flat Surface
Work Material	S50C
Cutting Speed	75m/min (2.387 min ⁻¹)
Feed Rate	430 mm/min (0,18 mm/rev)
Depth of Hole	20 mm (Through)
Coolant	Water Soluble
Machine	Horizontal Machining Center

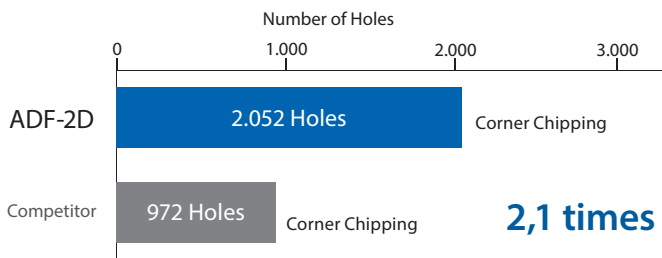

2,1 times

■ Oversize

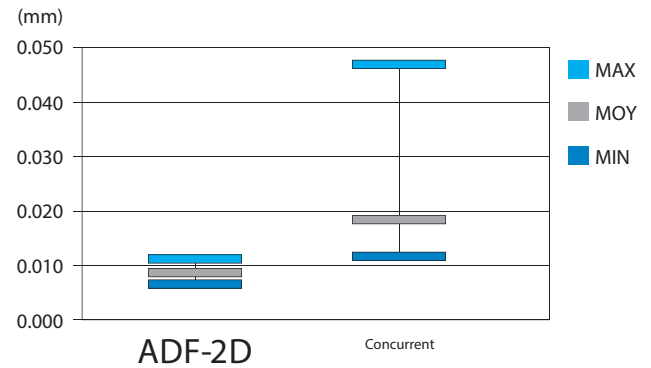

Inclined Surface

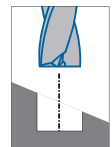

Tool	ADF-2D Ø10
Machined Surface	Angled Surface
Work Material	SCM440(30HRC)
Cutting Speed	60m/min (1.910 min ⁻¹)
Feed Rate	191 mm/min (0,1 mm/rev)
Depth of Hole	20 mm (Blind)
Coolant	Water Soluble
Machine	Horizontal Machining Center

■ Shift length in hole position

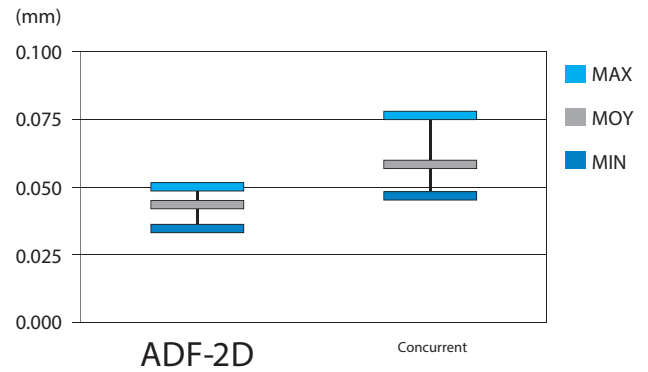
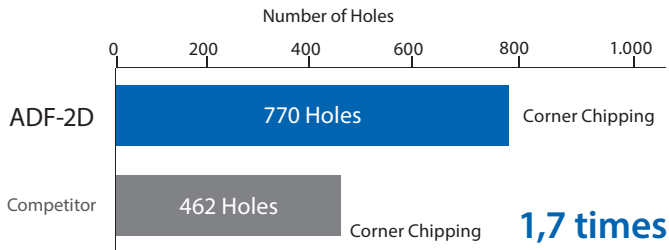

Superior performance even in stainless steel

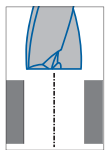

Tool	ADFO-3D Ø10
Machined Surface	Flat Surface
Work Material	SUS304
Cutting Speed	50m/min (1.592 min ⁻¹)
Feed Rate	239 mm/min (0,15 mm/rev)
Depth of Hole	30 mm (Through)
Coolant	Water Soluble
Machine	Horizontal Machining Center

■ Hole expansion comparison

ADFO-3D with minimal hole expansion variation

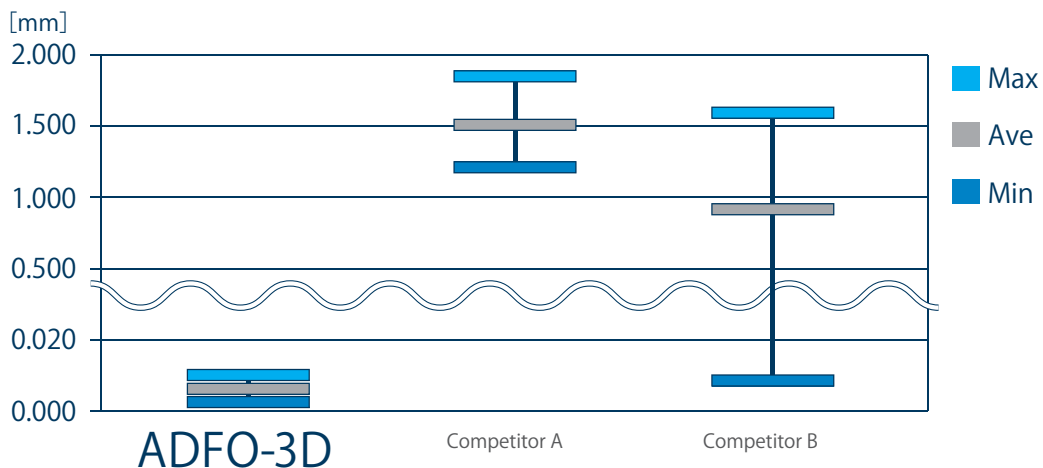

MACHINING DATA

Cutting Resistance Waveform

Stable thrust and torque (rigidity supported by the 20° helical grooves). Good chip evacuation (with no clogging of chips inside hole)

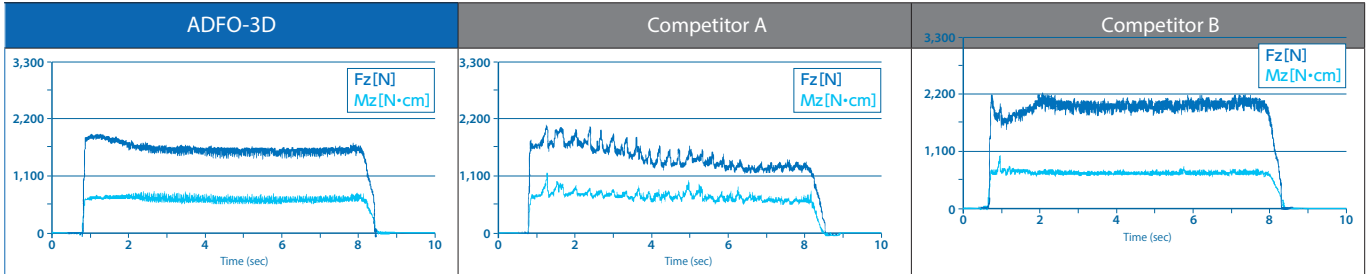

Chips

Only the ADFO-3D was capable of breaking chips into small, manageable pieces

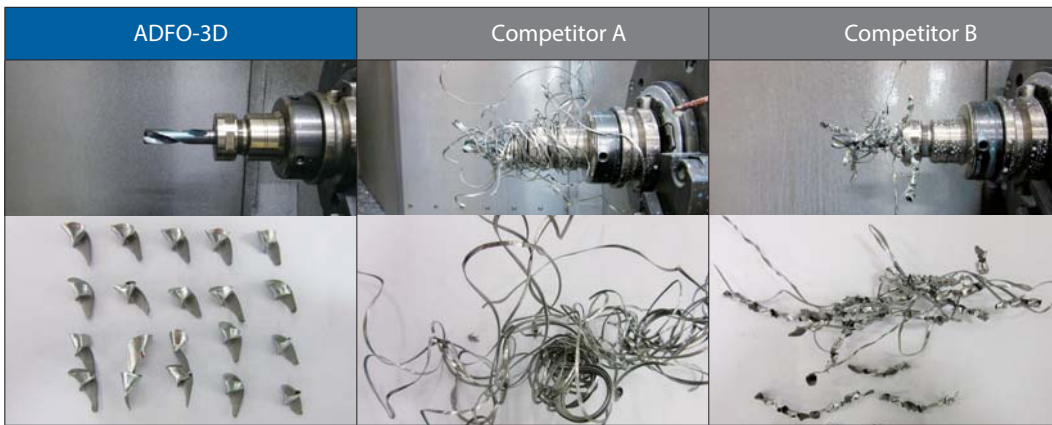

Durability

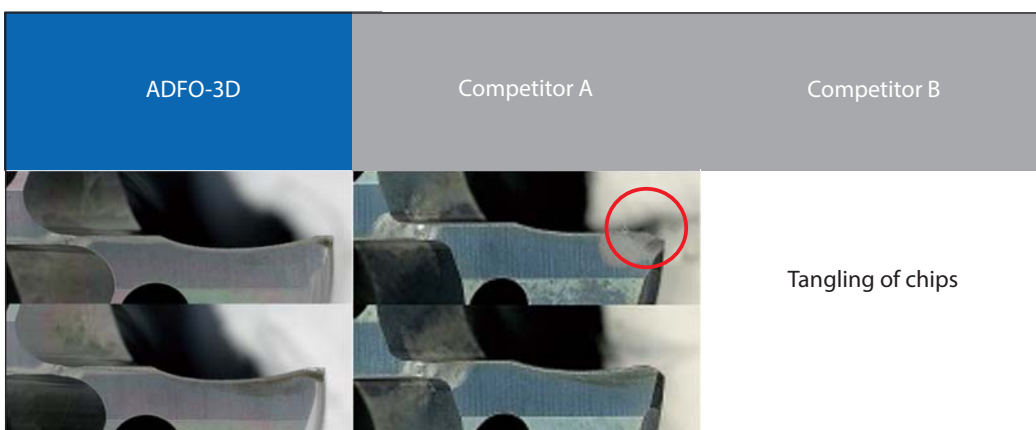
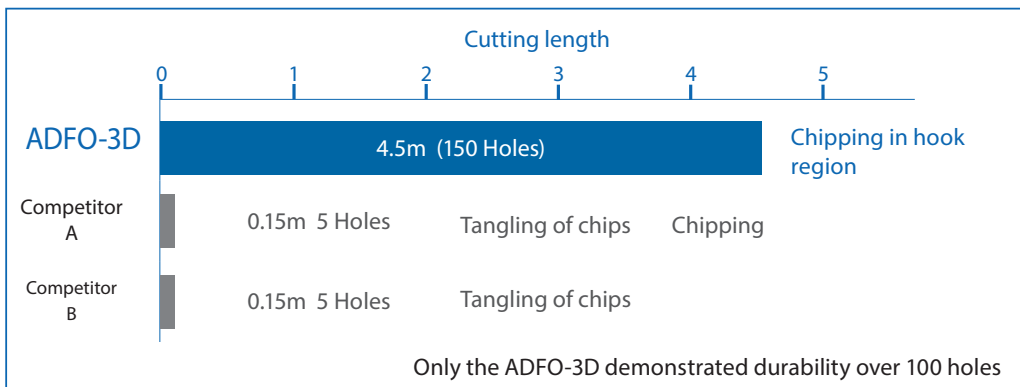

Stable processing of stainless steel even in small diameter

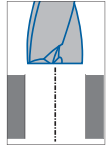

Tool	ADFO-3D Ø3
Machined Surface	Flat Surface
Work Material	SUS304
Cutting Speed	50m/min (5.305 min ⁻¹)
Feed Rate	239 mm/min (0,045 mm/rev)
Depth of Hole	9 mm (Through)
Coolant	Water Soluble
Machine	Horizontal Machining Center

ADFO-3D demonstrated controlled hole expansion and good durability

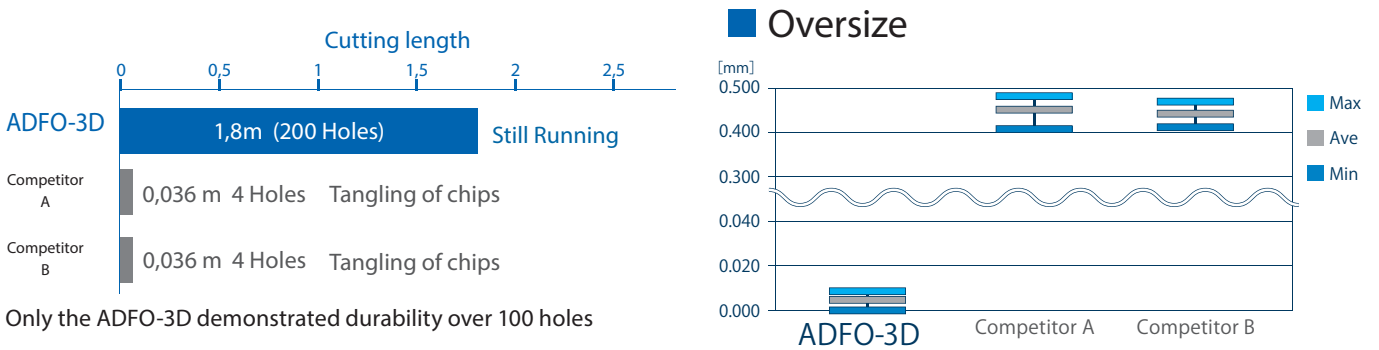

■ Damage comparison based on drill type used prior to threading

State of Damage	Drilling		Tapping	
	Hole Exit		Hole Exit	Wear on cutting edge after tapping 200 holes
Drilled by ADF		→		 Still Running
Drilled by Competitor's General Carbide Drill		→		 Chipping

With the use of a competitor's carbide general-purpose drill, large burrs were left resulting in instability of the after tapping process. With the ADF, on the other hand, stable tapping performance can be achieved.

Drilling | Solid carbide

Machining Data

Burrs suppressed by proprietary cutting edge geometry

Tool	ADFO-3D Ø16	
Machined Surface	Flat Surface	
Work Material	SS400	
Cutting Speed	100m/min (1.989 min ⁻¹)	
Feed Rate	636 mm/min (0,32 mm/rev)	318 mm/min (0,16 mm/rev)
Depth of Hole	10 mm (Through)	16,5 mm (Through)
Coolant	Water Soluble	
Machine	Horizontal Machining Center	

■ Comparison of exit burrs

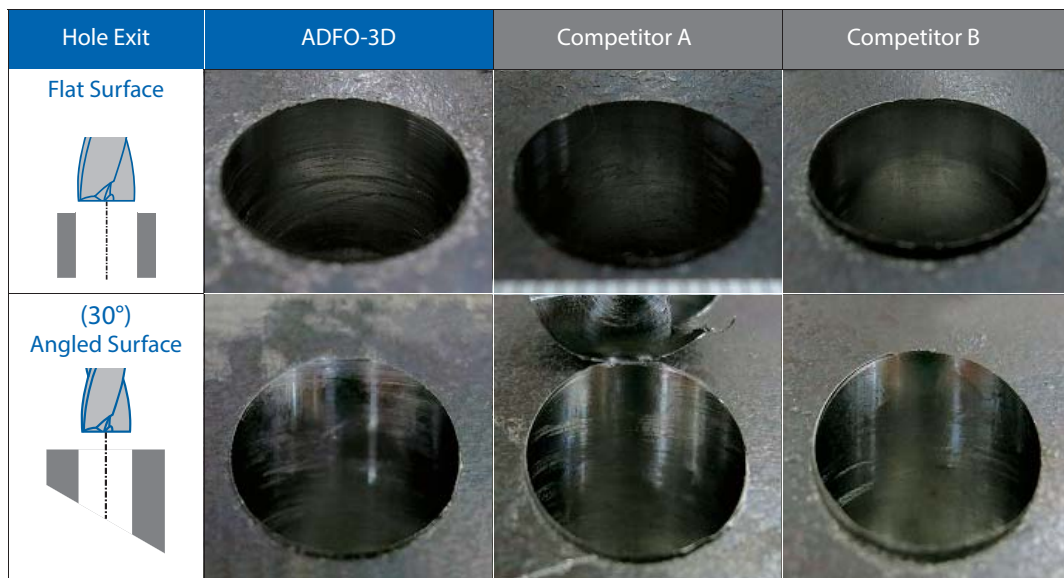

SWEDEN

Branch office of OSG SCANDINAVIA
Singelgatan 7
212 28 Malmö
Sweden
Tel: +46 40 41 22 55
osg@osg-scandinavia.com

OSG SCANDINAVIA

(For Scandinavian countries)
Langebjergvaenget 16
4000 Roskilde
Denmark
Tel: +45 46 75 65 55
osg@osg-scandinavia.com

OSG NETHERLANDS

Bedrijfsweg 5
3481 MG Harmelen
The Netherlands
Tel: +31 348 44 2764
Fax: +31 348 44 2144
info@osg-nl.com

OSG UK

Kelsey Close, Attleborough Fields Ind Est,
CV11 6RS, Nuneaton
United Kingdom
Tel: +44 1827 720 013
sales@osg-uk.com

OSG EUROPE LOGISTICS

Avenue Lavoisier 1
B-1300 Z.I. Wavre - Nord
Belgium
Tel: +32 10 23 05 07
Fax: +32 10 23 05 51
info@osgeurope.com

OSG BELUX

Avenue Lavoisier 1
B-1300 Z.I. Wavre - Nord
Belgium
Tel: +32 10 23 05 11
Fax: +32 10 23 05 31
info@osg-belgium.com

OSG IBÉRICA

Bekolarra 4
E - 01010 Vitoria-Gasteiz
Spain
Tel: +34 945 242 400
Fax: +34 945 228 883
osg.iberica@osg-ib.com

OSG FRANCE

Parc Icade, Paris Nord 2
Immeuble "Le Rimbaud"
22 Avenue des Nations
CS66191 - 93420 Villepinte
France
Tel: +33 1 49 90 10 10
Fax: +33 1 49 90 10 15
sales@osg-france.com

OSG ITALY

Via Ferrero, 65 A/B
I - 10098 Rivoli
Italy
Tel: +39 0117705211
Fax: +39 0117705215
info@osg-italia.it



OSG IN EUROPE

CZECH REPUBLIC, SLOVAKIA, HUNGARY

OSG Europe Logistics S.A.
Slovakia, organizačná zložka
Račianska 22/A, Bratislava 831 02
Slovakia
Tel.: +421 24 32 91 295
info@osgeurope.com

OSG POLAND

ul. Spółdzielcza 57
05-074 Halinów
Polska
Tel: +22 760 82 71
Mob. +48 570 677 711
osg@osg-poland.com

OSG RUSSIA

Butlerova street, 17B, office 5069
117342 Moscow
Russia
Tel: +7 (495) 150 41 54
info@osg-russia.com

ROMSAN INTERNATIONAL CO. SRL

Reprezentant Exclusiv OSG
25C, Bucuresti-Magurele Street
051431 Bucuresti
România
Tel: +40 21 322 07 47
Fax: +40 21 321 56 00
romsan.int@romsan.ro

OSG TURKEY

Rami Kişla Cad.No:56 Eyüp
İstanbul 34056
Turkey
Tel: +90 212 565 24 00
Fax: +90 212 565 44 00
info@osg-turkey.com

Vischer & Bolli AG

Machining and Workholding
Im Schossacher 17
CH-8600 Dübendorf
Schweiz
Tel.: +41 44 802 15 15
Fax: +41 44 802 15 95
info@vb-tools.com

OSG GERMANY

Karl-Ehmann-Str. 25
D - 73037 Göppingen
Germany
Tel: +49 7161 6064 - 0
Fax: +49 7161 6064 - 444
info@osg-germany.de



shaping your dreams

OSG EUROPE LOGISTICS

Avenue Lavoisier 1
B-1300 Z.I. Wavre - Nord - Belgium
Tel: +32 10 23 05 07
Fax: +32 10 23 05 51
info@osgeurope.com

OSG POLAND Sp. z o.o.

Spółdzielcza 57
05-074 Halinów - Poland
Tel: +22 760 82 71
Fax: +22 760 82 71
osg@osg-poland.com

OSG TURKEY

Rami Kişla Cad.No:56 Eyüp
Istanbul 34056 - Turkey
Tel+90 212 565 24 00
Fax: +90 212 565 44 00
info@osg-turkey.com

OSG BELUX

Avenue Lavoisier 1
B-1300 Z.I. Wavre - Nord - Belgium
Tel: +32 10 23 05 11
Fax: +32 10 23 05 31
info@osg-belgium.com

OSG GERMANY

Karl-Ehmann-Str. 25
D - 73037 Göppingen - Germany
Tel: +49 7161 6064 - 0
Fax: +49 7161 6064 - 444
info@osg-germany.de

ROMSAN INTERNATIONAL CO. SRL

Reprezentant Exclusiv OSG
25C, Bucuresti-Magurele Street
051431 Bucuresti - România
Tel: +40 21 322 07 47
Fax: +40 21 321 56 00
romsan.int@romsan.ro

OSG FRANCE

Parc Icade, Paris Nord 2
Immeuble "Le Rimbaud"
22 Avenue des Nations
CS66191 - 93420 Villepinte - France
Tel: +33 1 49 90 10 10
Fax: +33 1 49 90 10 15
sales@osg-france.com

OSG SCANDINAVIA

(For Scandinavian countries)
Langebjergvaenget 16
4000 Roskilde - Denmark
Tel: +45 46 75 65 55
Fax: +45 46 75 67 00
osg@osg-scandinavia.com

AUSTRIA

Branch office of OSG GERMANY
Messestraße 11
A-6850 Dornbirn
Tel: +49 7161 6064-0
Fax: +49 7161 6064-444
info@osg-germany.de

OSG NETHERLANDS

Bedrijfsweg 5 - 3481 MG Harmelen
Tel: +31 348 44 2764
Fax: +31 348 44 2144
info@osg-nl.com

SWEDEN

Branch office of OSG SCANDINAVIA
Singelgatan 7
212 28 Malmö - Sweden
Tel: +46 40 41 22 55
osg@osg-scandinavia.com

OSG ITALIA

Via Ferrero, 65 A/B3
I - 10098 Rivoli - Italy
Tel: +39 0117705211
Fax: +39 0117705215
info@osg-italia.it

OSG UK

Kelsey Close, Attleborough Fields Ind Est,
CV11 6RS, Nuneaton, United Kingdom.
Tel: +44 1827 720 013
uk_sales@osg-uk.com

OSG IBERICA

Bekolarra 4
E - 01010 Vitoria-Gasteiz - Spain
Tel: +34 945 242 400
Fax: +34 945 228 883
osg.iberica@osg-ib.com

Vischer & Bolli AG

Machining and Workholding
Im Schossacher 17
CH-8600 Dübendorf
T +41 44 802 15 15
F +41 44 802 15 95
info@vb-tools.com

CZECH, SLOVAKIA, HUNGARY

OSG Europe Logistics S.A.
Slovakia organizacna zlozka
Racianská 22/A, SK-83102 Bratislava
Slovakia
Tel. +421 24 32 91 295
Orders-osgsvk@osgeurope.com

RUSSIA

Butlerova street, 17B, office 5069
117342 Moscow - Russia
Tel: +7 (495) 150 41 54
info@osg-russia.com

OSG EUROPE LOGISTICS S.A.

08/2023 - All rights reserved. © OSG Europe 2023

The contents of this catalogue are provided to you for viewing only. They are not intended for reproduction either in part or in whole in this or other medium. They cannot be copied, used to create derivation work or used for any reason, by means without the express, written permission of the copyright owner. If prices are stated, they are netto unit-prices and any eventual tax(es) have to be added. The company is not responsible for any printing error in technical, price and/or any other data.

Tool specifications subject to change without notice.

www.osgeurope.com

