



Tap Holder

SYNCHROMASTER SYNCHROFIT

Volume 2



KEY FEATURES: SYNCHROMASTER

1 Enables accurate depth control
Achieves stable performance even with difficult small chamfer

3 Prevents sudden breakage

2 Improves thread quality

4 Prolongs tool life

5 The combination of SynchroMaster and synchronous feed machines brings out the best of your A-TAP tools



SYNCHROMASTER TAP HOLDER

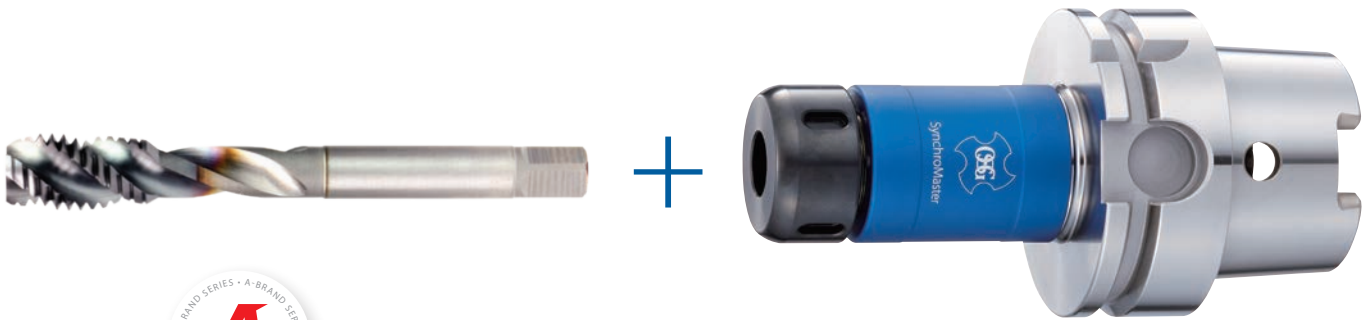

A-TAP & SYNCHROMASTER THE BEST SOLUTION

SynchroMaster reduces axial and radial forces to enable the A-Tap series to reach its maximum potential !

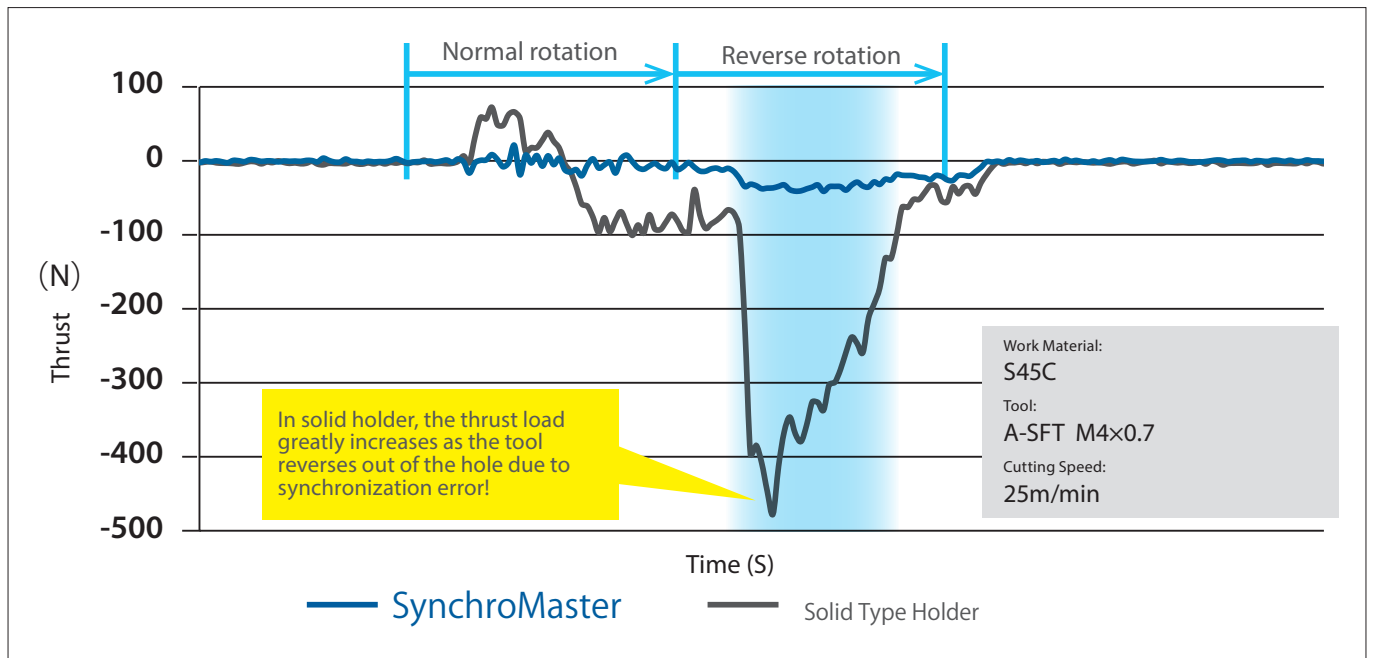

Machine	Holder	Tap (example)	Recommendation
Machine with synchronous feed mechanism	SynchroMaster	A-TAP (A-SFT, A-POT, S-XPf)	●
		General purpose tap (EX-SFT, TIN-POT)	○

Synchro Tap is recommended to be used in combination with a solid holder and machine with synchronous feed mechanism

●: Best ○: Good



SYNCHROMASTER TAP HOLDER

The secret lies in its integrated single unit construction!

- Original metal flexure mechanism enables long tool life
- Ultra-small float mechanism ensures consistent tapping depth



- Disadvantages of General micro float holder
- Float mechanism that allows the 2-piece body construction with resin or rubber type damper to move in the thrust direction
 - Early degradation of the damper mechanism
 - Requires maintenance

Long tool life

Stable performance even with difficult short chamfer

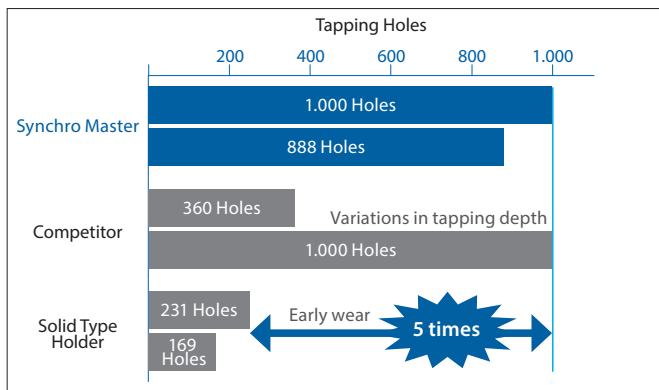

Work Material: S45C Tool: A-SFT M4×0.7 1P Cutting Speed: 10m/min

Durability of forming taps can also be improved

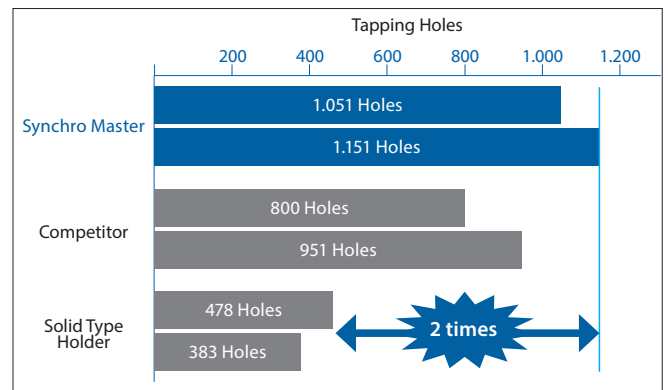

Work Material: SCM440 (30HRC) Tool: S-XPf M10×1.5 2P Cutting Speed: 15m/min

Suppresses variations in tapping depth

Achieves high precision tapping depth comparable to solid type holder

Holder	Tap (example)
SynchroMaster	0.10 mm
Competitor	0.20 mm
Solid Type Holder	0.07 mm

Work Material: S45C Tool: S-XPf M10×1,5 2P Cutting Speed: 22m/min

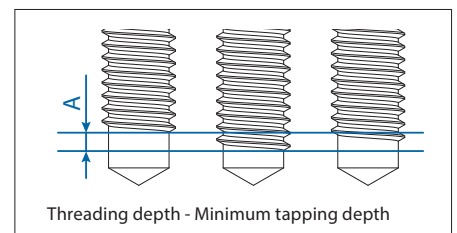

SynchroMaster (Holder+Nut)



Collet (Sold separately)



Spanner (Sold separately)

SYNCHROMASTER NEW SIZES

Threading | Holders | SynchroMaster



- Tap holder synchronized
- Improve the tool life
- For tapping sizes from M3 to M12
- HSK, BT and ST type for ER16 collet type

HSK shank holder

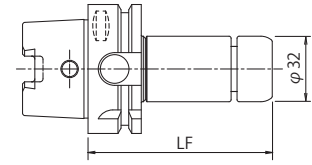

BT shank holder

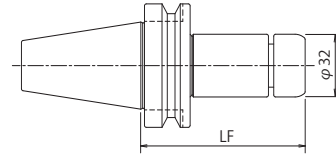

ST shank holder

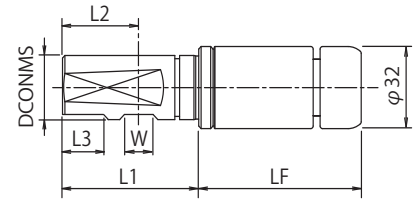

EDP	Designation	LF	L1	L2	L3	DCONMS	w	Tap size	Price
79924*	ST20D-SMH16-68	68	51	25	-	20	11	M3~M12	
79925	ST25D-SMH16-68	68	57	32	17	25	12	M3~M12	
79912	HSK40A-SMH16-85	85	-	-	-	-	-	M3~M12	
79913	HSK63A-SMH16-90	90	-	-	-	-	-	M3~M12	
79910	BT30-SMH16-90	90	-	-	-	-	-	M3~M12	
79911	BT40-SMH16-90	90	-	-	-	-	-	M3~M12	

Note *: The ST20D does not include the L3 flat section.

1. The collet and spanner are sold separately. The HSK40A is without manual clamping hole
2. Refer to the following chart for the corresponding tap size
3. Please use a machine with synchronous feed capability

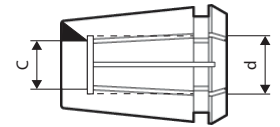

SynchroMaster Collet chuck

EDP	Collet chuck	C (mm)	d (mm)	DIN371	DIN376	Price
79949	ER16GH-3.5-2.7	2,7	3,5	M3	M5	
79951	ER16GH-4.5-3.4	3,4	4,5	M4	M6	
79953	ER16GH-6-4.9	4,9	6	M5, M6	M8	
79919	ER16GH-7-5.5	5,5	7	M7	M10	
79955	ER16GH-8-6.3	6,3	8	M8	M11	
79956	ER16GH-9-7.1	7,1	9	M9	M12	

1. For center-through coolant system, please insert the tool all the way to the back of the collet. Coolant leakage may occur if the tool insertion length is too short.
2. Select the appropriate collet after confirming the dimensions of the tap to be used.
3. Please confirm the tightening torque with a torque spanner or similar tool.

Accessories & spare parts

EDP	Wrench	Cap nut	Price
79923	FKT-32L	-	
79922	-	ERP-16T	

KEY FEATURES: SFH SYNCHROFIT

1 Cap nut with ball-bearing for high run out accuracy and clamping force

2 Patented thrust force compensator: compensates for deviations radially and axially, reducing flank wear and cutting torque

3 Coolant transfer unit



SFH SYNCHROFIT TAP HOLDER

Modern CNC machine tapping centers are designed to synchronize spindle rotation with the feed axis. In rigid tapping high axial forces have to be absorbed by the tap's thread flanks. This increased abrasive flank wear reduces the tool life of the tap as well as the surface quality and accuracy to gauge of the thread resulting in a significant decrease of process reliability, this may result in breakage of the tap. SynchroFit Tap Holder with it's new wear free radial cutting force compensation reduces the tap flank wear significantly.



- Increased tool life
- Higher thread quality
- Increased process reliability

Most Synchro Tapping Chucks having a simple minimal length compensation using plastic elements. Deforming and harden appears after some time until compensation of synchronisation error is not possible anymore. Lifetime is reduced drastically compared to SynchroFit.



SFH SYNCHROFIT TAPPING HOLDER

Tapping process

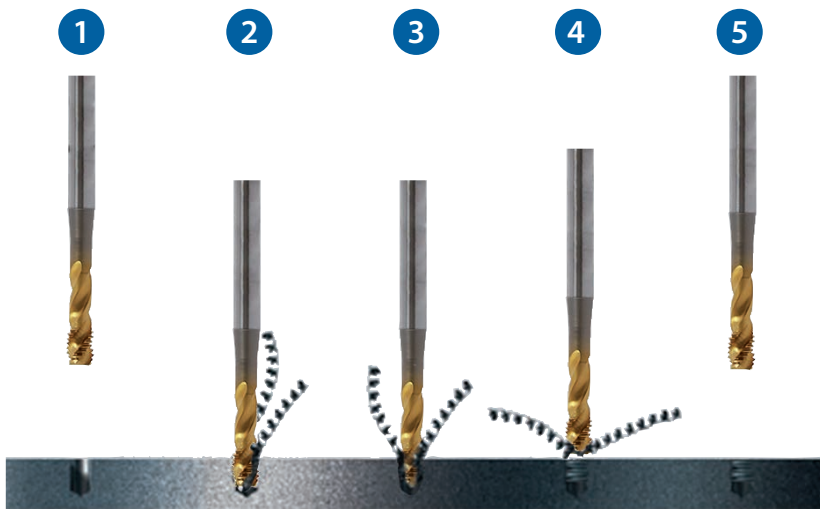

- **Step 1 & 2**
When cutting process starts, torque is increasing strongly.
- **Step 3**
When the spindle stops the torque is zero.
- **Step 4**
Again torque is increasing due to cutting of the residual chip at the end of the thread.
- **Step 5**
Torque is decreasing steadily down to zero. (depending on direction of rotation)

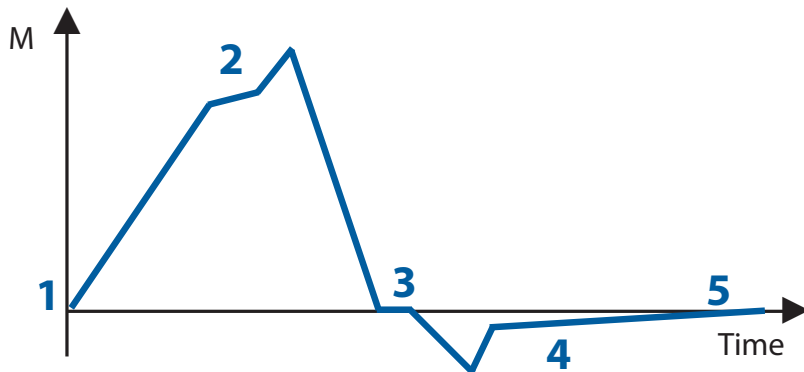

Tool life comparison

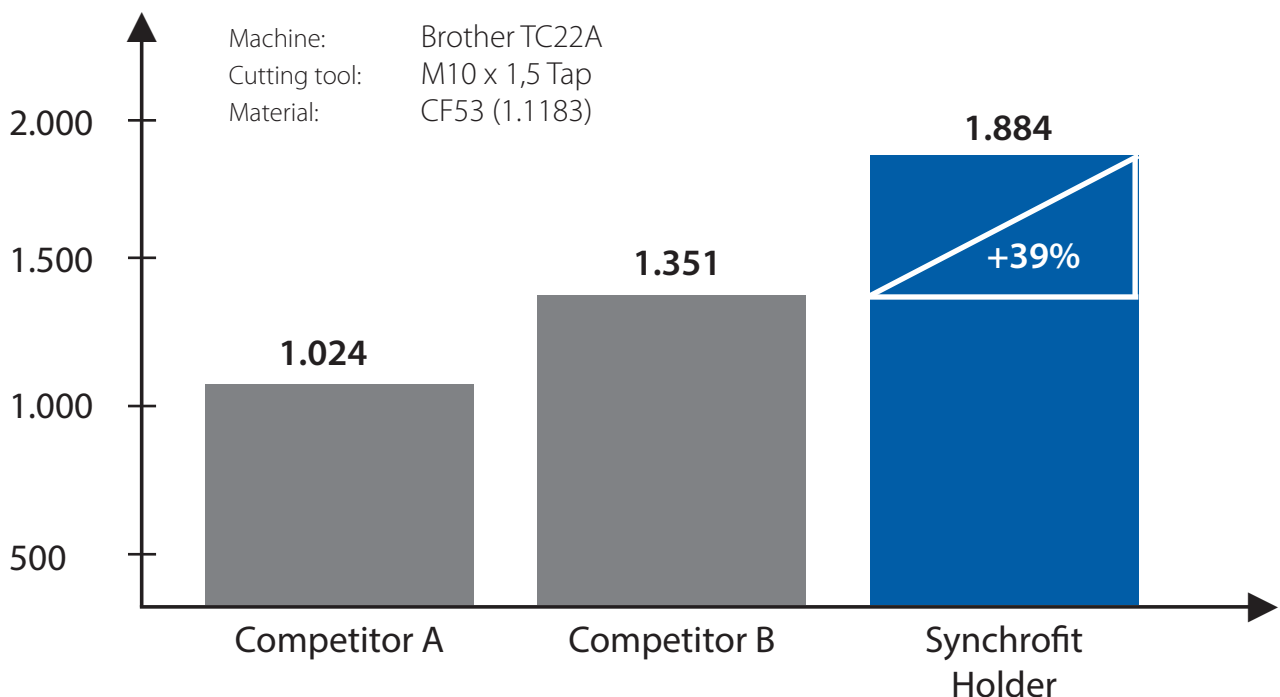

SYNCHROFIT

Threading | Holder | Synchrofit

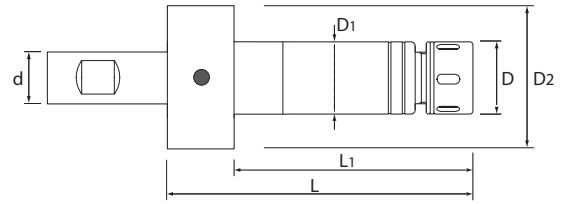
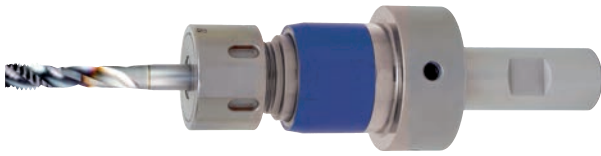

- Tap holder with radial cutting force compensation
- Improve the tool life
- For tapping sizes from M4 to M20
- Straight shank type, for ER16-GB and ER-25-GB collet type



EDP	Designation	D	D1	D2	L	L1	d	Price
EP01922000	ST20-SFH-ER16-80	32	34	45	80	60	20	
EP01922500	ST25-SFH-ER16-80	32	34	45	80	60	25	
EP01922001	ST20-SFH-ER25-105	42	40	45	105	85	20	
EP01922501	ST25-SFH-ER25-105	42	40	45	105	85	25	

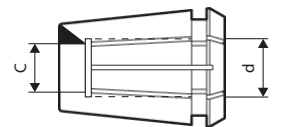

Synchrofit Collet chuck

EDP	Collet chuck	C (mm)	d (mm)	DIN371	DIN376	Price
248000304516	ER 16-GB	3,4	Ø 4,5	M4	M6	
248000306016	ER 16-GB	4,9	Ø 6,0	M5 - M6	M8	
248000308016	ER 16-GB	6,2	Ø 8,0	M8	M11	
248000316025	ER 25-GB	4,9	Ø 6,0	M5 - M6	M8	
248000318025	ER 25-GB	6,2	Ø 8,0	M8	M11	
248000319025	ER 25-GB	7,0	Ø 9,0	M9	M12	
248000310025	ER 25-GB	8,0	Ø 10	M10	-	
248000311025	ER 25-GB	9,0	Ø 11	-	M14	
248000312025	ER 25-GB	9,0	Ø 12	-	M16	
248000314025	ER 25-GB	11,0	Ø 14	-	M18	
163000311060	ER 25-GB	12,0	Ø 16	-	M20	

Accessories

EDP	Applicable for collet chuck	Wrench	Price
244500000034	ER 16-GB	FK-0034	
071100001016	ER 25-GB	HS-1-16	

SWEDEN

Branch office of OSG SCANDINAVIA
Abrahams Gränd 8
295 35 Bromölla
Sweden
Tel: +46 40 41 22 55
osg@osg-scandinavia.com

OSG SCANDINAVIA

(For Scandinavian countries)
Langebjergvaenget 16
4000 Roskilde
Denmark
Tel: +45 46 75 65 55
osg@osg-scandinavia.com

OSG NETHERLANDS

Bedrijfsweg 5
3481 MG Harmelen
The Netherlands
Tel: +31 348 44 2764
Fax: +31 348 44 2144
info@osg-nl.com

OSG UK

Shelton house, 5 Bentalls
Pipps Hill Ind Est, Basildon Essex SS14 3BY
United Kingdom
Tel: +44 1268 567660
Fax: +44 1268 567661
sales@osg-uk.com

OSG EUROPE LOGISTICS

Avenue Lavoisier 1
B-1300 Z.I. Wavre - Nord
Belgium
Tel: +32 10 23 05 07
Fax: +32 10 23 05 51
info@osgeurope.com

OSG BELUX

Avenue Lavoisier 1
B-1300 Z.I. Wavre - Nord
Belgium
Tel: +32 10 23 05 11
Fax: +32 10 23 05 31
info@osg-belgium.com

OSG IBÉRICA

Bekolarra 4
E - 01010 Vitoria-Gasteiz
Spain
Tel: +34 945 242 400
Fax: +34 945 228 883
osg.iberica@osg-ib.com

OSG FRANCE

Parc Icade, Paris Nord 2
Immeuble "Le Rimbaud"
22 Avenue des Nations
CS66191 - 93420 Villepinte
France
Tel: +33 1 49 90 10 10
Fax: +33 1 49 90 10 15
sales@osg-france.com

OSG ITALY

Via Ferrero, 65 A/B
I - 10098 Rivoli
Italian
Tel: +39 0117705211
Fax: +39 0117705215
info@osg-italia.it





CZECH REPUBLIC, SLOVAKIA, HUNGARY

OSG Europe Logistics S. A.
Slovakia, organizačná zložka
Račianska 22/A, Bratislava 831 02
Slovakia
Tel.: +421 24 32 91 295
info@osgeurope.com

OSG POLAND

ul. Spółdzielcza 57
05-074 Halinów
Polska
Tel: +22 760 82 71
Mob. +48 570 677 711
osg@osg-poland.com

OSG RUSSIA

Butlerova street, 17B, office 5069
117342 Moscow
Russia
Tel: +7 (495) 150 41 54
info@osg-russia.com

ROMSAN INTERNATIONAL CO. SRL

Reprezentant Exclusiv OSG
25C, Bucuresti-Magurele Street
051431 Bucuresti
România
Tel: +40 21 322 07 47
Fax: +40 21 321 56 00
romsan.int@romsan.ro

OSG TURKEY

Rami Kışla Cad.No:56 Eyüp
Istanbul 34056
Turkey
Tel: +90 212 565 24 00
Fax: +90 212 565 44 00
info@osg-turkey.com

Vischer & Bolli AG

Machining and Workholding
Im Schossacher 17
CH-8600 Dübendorf
Schweiz
Tel.: +41 44 802 15 15
Fax: +41 44 802 15 95
info@vb-tools.com

OSG GERMANY

Karl-Ehmann-Str. 25
D - 73037 Göppingen
Germany
Tel: +49 7161 6064 - 0
Fax: +49 7161 6064 - 444
info@osg-germany.de



shaping your dreams

OSG EUROPE LOGISTICS

Avenue Lavoisier 1
B-1300 Z.I. Wavre - Nord - Belgium
Tel: +32 10 23 05 07
Fax: +32 10 23 05 51
info@osgeurope.com

OSG BELUX

Avenue Lavoisier 1
B-1300 Z.I. Wavre - Nord - Belgium
Tel: +32 10 23 05 11
Fax: +32 10 23 05 31
info@osg-belgium.com

OSG FRANCE

Parc Icade, Paris Nord 2
Immeuble "Le Rimbaud"
22 Avenue des Nations
CS66191 - 93420 Villepinte - France
Tel: +33 1 49 90 10 10
Fax: +33 1 49 90 10 15
sales@osg-france.com

OSG NETHERLANDS

Bedrijfsweg 5 - 3481 MG Harmelen
Tel: +31 348 44 2764
Fax: +31 348 44 2144
info@osg-nl.com

OSG UK

Shelton house, 5 Bentalls
Pipps Hill Ind Est, Basildon Essex SS14 3BY
Tel: +44 1268 567 660
Fax: +44 1268 567 661
sales@osg-uk.com

CZECH, SLOVAKIA, HUNGARY

OSG Europe Logistics S.A.
Slovakia organizacna zlozka
Racianská 22/A, SK-83102 Bratislava
Slovakia
Tel. +421 24 32 91 295
Orders-osgsvk@osgeurope.com

OSG POLAND Sp. z.o.o.

Spółdzielcza 57
05-074 Halinów - Poland
Tel: +22 760 82 71
Fax: +22 760 82 71
osg@osg-poland.com

OSG GERMANY

Karl-Ehmann-Str. 25
D - 73037 Göppingen - Germany
Tel: +49 7161 6064 - 0
Fax: +49 7161 6064 - 444
info@osg-germany.de

OSG SCANDINAVIA

(For Scandinavian countries)
Langebjergvaenget 16
4000 Roskilde - Denmark
Tel: +45 46 75 65 55
Fax: +45 46 75 67 00
osg@osg-scandinavia.com

SWEDEN

Branch office of OSG SCANDINAVIA
Abrahams Gränd 8
295 35 Bromölla - Sweden
Tel: +46 40 41 22 55
Fax: +46 40 41 32 55
osg@osg-scandinavia.com

OSG IBERICA

Bekolarra 4
E - 01010 Vitoria-Gasteiz - Spain
Tel: +34 945 242 400
Fax: +34 945 228 883
osg.iberica@osg-ib.com

RUSSIA

Butlerova street, 17B, office 5069
117342 Moscow - Russia
Tel: +7 (495) 150 41 54
info@osg-russia.com

OSG TURKEY

Rami Kişla Cad.No:56 Eyüp
Istanbul 34056 - Turkey
Tel:+90 212 565 24 00
Fax: +90 212 565 44 00
info@osg-turkey.com

ROMSAN INTERNATIONAL CO. SRL

Reprezentant Exclusiv OSG
25C, Bucuresti-Magurele Street
051431 Bucuresti - România
Tel: +40 21 322 07 47
Fax: +40 21 321 56 00
romsan.int@romsan.ro

AUSTRIA

Branch office of OSG GERMANY
Messestraße 11
A-6850 Dornbirn
Tel: +49 7161 6064-0
Fax: +49 7161 6064-444
info@osg-germany.de

OSG ITALIA

Via Ferrero, 65 A/B
I - 10098 Rivoli - Italy
Tel: +39 0117705211
Fax: +39 0117705215
info@osg-italia.it

Vischer & Bolli AG

Machining and Workholding
Im Schossacher 17
CH-8600 Dübendorf
T +41 44 802 15 15
F +41 44 802 15 95
info@vb-tools.com

OSG EUROPE LOGISTICS S.A.

01/2021- All rights reserved. © OSG Europe 2021.

The contents of this catalogue are provided to you for viewing only. They are not intended for reproduction either in part or in whole in this or other medium. They cannot be copied, used to create derivation work or used for any reason, by means without the express, written permission of the copyright owner. If prices are stated, they are netto unit-prices and any eventual tax(es) have to be added. The company is not responsible for any printing error in technical, price and/or any other data.

Tool specifications subject to change without notice.

www.osgeurope.com