

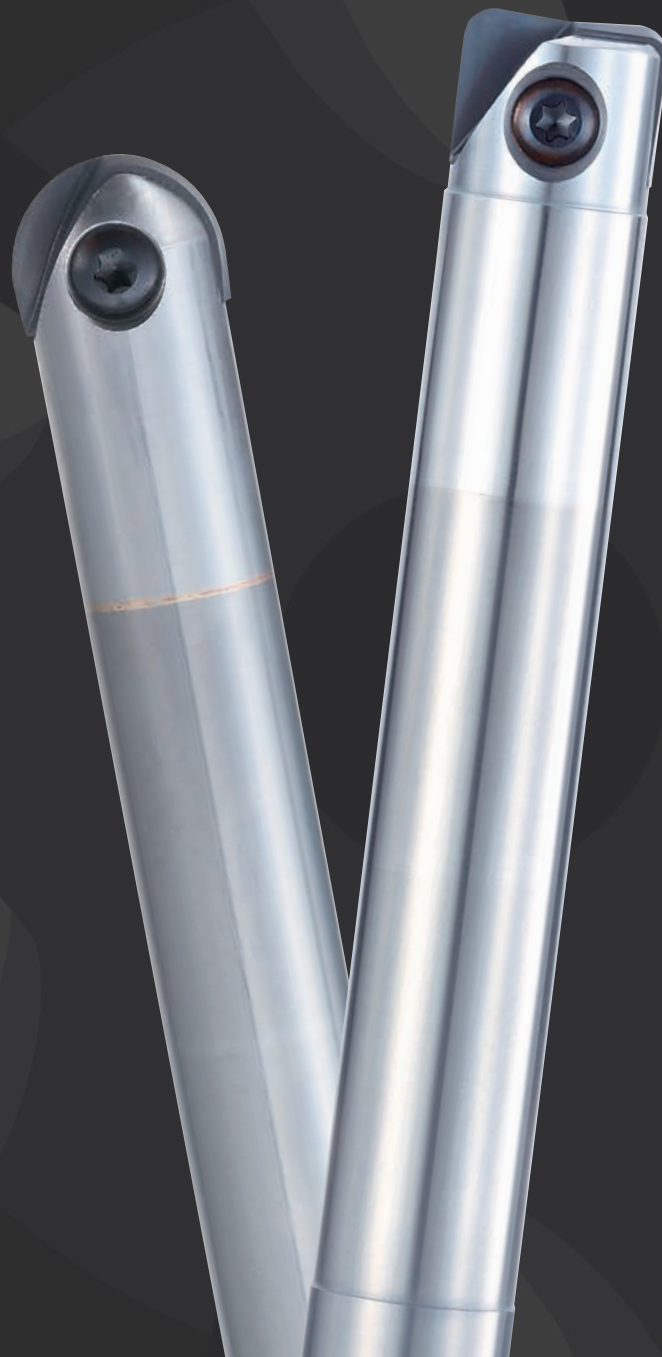

Finishing Ball & Radius End Mill

PFB PFR

Volume 2



FEATURES: PHOENIX PFB

1 Indexable insert

2 Finish ball nose cutter
2 flutes

3 Short, long & extra long type
Carbide Shank

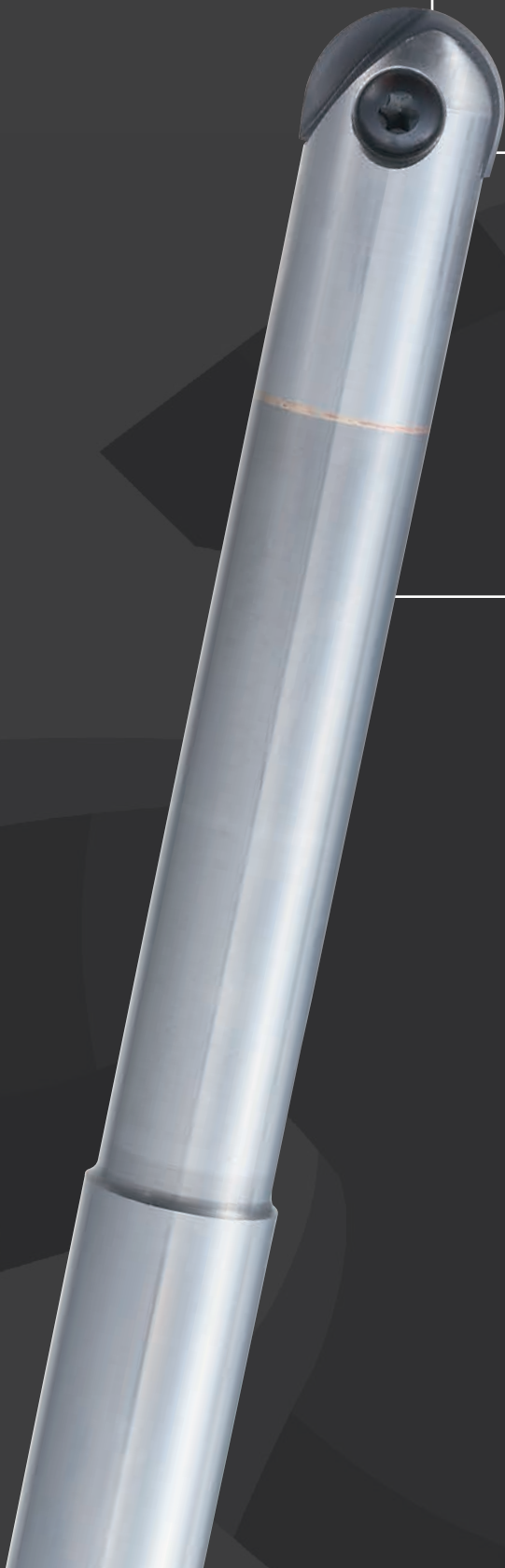

PFB INSERTS

Milling | Indexables

High Radius precision

Spiral cutting edge with excellent sharpness

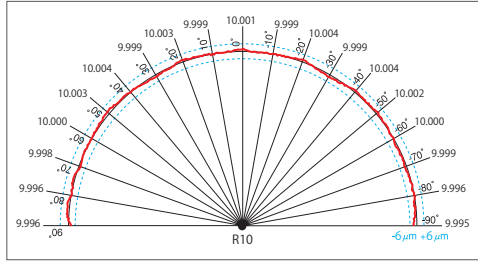

Type

PFB-SP

- Applicable to a wide variety of work materials from mild steel to HRSA
- Sharp but rigid cutting edge
- Excellent chipping resistance

PFB-Q

- Applicable to undercuts with 220° effective cutting edge angle
- No straight cutting edge at the outer peripheral surface, which is applicable to standing wall milling that occurs chattering

PFB-SH

- For milling cast iron, ductile iron and Hardened steel
- Strong cutting edge by the special processing
- Highly resistant carbide material

PFB-D

- Sharp cutting edge specialized for milling graphite
- Highly adhesive carbide material for diamond coating

Grade

XP3320 Grade

- For dry milling of steel, stainless steel, and cast iron
- For wet milling of HRSA

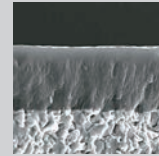

→ Heat resistant coating
→ Wear resistant coating

XP3225 Grade

- For stable milling of a wide variety of work materials
- Excellent lubricity and wear resistance
- For wet milling of steel and stainless steel

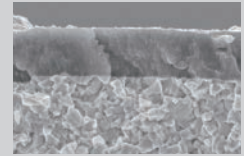

XP3310 Grade

- Ideal for dry milling of high hardened steel and cast iron
- Excellent heat and wear resistance

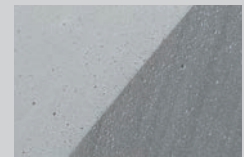

XC4505 Grade

- For milling nonferrous material
- Optimal diamond coating for milling graphite

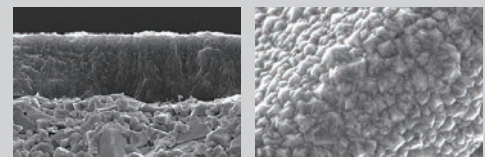

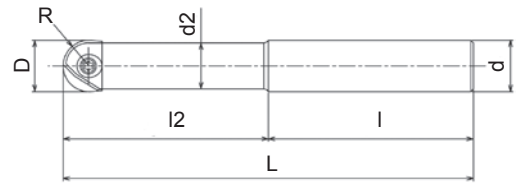

- Finishing ball nose cutter
- Excellent sharpness
- Cylindrical type
- 6 - 32 mm

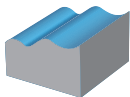

EDP	Body size	Designation	Z	D	R	I2	I2/D	I	L	d2	d	Specification	Price
7801429	①	PFB-R060SS06-S80CS	2	6	3	15	2,5	65	80	5,4	6	Carbide	
7801439	①	PFB-R060SS06-L100CS	2	6	3	30	5	70	100	5,4	6	Carbide	
7801419	①	PFB-R060SS06-LL120CS	2	6	3	42	7	78	120	5,4	6	Carbide	
7801430	②	PFB-R080SS08-S100CS	2	8	4	20	2,5	80	100	7	8	Carbide	
7801440	②	PFB-R080SS08-L120CS	2	8	4	40	5	80	120	7	8	Carbide	
7801420	②	PFB-R080SS08-LL140CS	2	8	4	56	7	84	140	7	8	Carbide	
7801431	③	PFB-R100SS10-S100CS	2	10	5	25	2,5	75	100	9	10	Carbide	
7801441	③	PFB-R100SS10-L130CS	2	10	5	50	5	80	130	9	10	Carbide	
7801421	③	PFB-R100SS10-LL150CS	2	10	5	70	7	80	150	9	10	Carbide	
7801432	④	PFB-R120SS12-S110CS	2	12	6	30	2,5	80	110	11	12	Carbide	
7801442	④	PFB-R120SS12-L140CS	2	12	6	60	5	80	140	11	12	Carbide	
7801422	④	PFB-R120SS12-LL160CS	2	12	6	84	7	76	160	11	12	Carbide	
7801433	⑤	PFB-R160SS16-S140CS	2	16	8	40	2,5	100	140	14	16	Carbide	
7801443	⑤	PFB-R160SS16-L160CS	2	16	8	72	4,5	88	160	14	16	Carbide	
7801423	⑤	PFB-R160SS16-LL200CS	2	16	8	96	6	104	200	14	16	Carbide	
7801434	⑥	PFB-R200SS20-S160CS	2	20	10	50	2,5	110	160	18	20	Carbide	
7801444	⑥	PFB-R200SS20-L180CS	2	20	10	90	4,5	90	180	18	20	Carbide	
7801424	⑥	PFB-R200SS20-LL240CS	2	20	10	120	6	120	240	18	20	Carbide	
7801435	⑦	PFB-R250SS25-S160CS	2	25	12,5	62,5	2,5	97,5	160	22	25	Carbide	
7801445	⑦	PFB-R250SS25-L200CS	2	25	12,5	100	4	100	200	22	25	Carbide	
7801425	⑦	PFB-R250SS25-LL260CS	2	25	12,5	137,5	5,5	122,5	260	22	25	Carbide	
7801436	⑧	PFB-R300SS32-S170CS	2	30	15	75	2,5	95	170	27	32	Carbide	
7801446	⑧	PFB-R300SS32-L220CS	2	30	15	120	4	100	220	27	32	Carbide	
7801426	⑧	PFB-R300SS32-LL290CS	2	30	15	165	5,5	125	290	27	32	Carbide	
7801437	⑨	PFB-R320SS32-S180CS	2	32	16	80	2,5	100	180	29	32	Carbide	
7801447	⑨	PFB-R320SS32-L230CS	2	32	16	128	4	102	230	29	32	Carbide	
7801427	⑨	PFB-R320SS32-LL300CS	2	32	16	176	5,5	124	300	29	32	Carbide	
7801400	②	PFB-R080SS08-S120	2	8	4	36	4,5	84	120	7	8	Steel	
7801401	③	PFB-R100SS10-S130	2	10	5	45	4,5	85	130	9	10	Steel	
7801402	④	PFB-R120SS12-S130	2	12	6	54	4,5	76	130	11	12	Steel	
7801403	⑤	PFB-R160SS16-S140	2	16	8	64	4	76	140	14	16	Steel	
7801404	⑥	PFB-R200SS20-S160	2	20	10	80	4	80	160	18	20	Steel	
7801405	⑦	PFB-R250SS25-S160	2	25	12,5	75	3	85	160	22	25	Steel	
7801406	⑧	PFB-R300SS32-S170	2	30	15	90	3	80	170	27	32	Steel	
7801407	⑨	PFB-R320SS32-S180	2	32	16	96	3	84	180	29	32	Steel	

Accessories & spare parts

Applicable cutter Ø	Tightening torque (recommended)	Clamping screw		Wrench	
		Clamping screw	Wrench	Clamping screw	Wrench
Ø 6	0,8Nm	7808124	FS20652RB	7808203	T6-D
Ø 8	1Nm	7808123	FS25669RB	7808204	T7-D
Ø 10	1,2Nm	7808117	FS30686RB	7808205	T8-D
Ø 12	2Nm	7808118	FS35610RB	7808207	T10-D
Ø 16	3Nm	7808119	FS40613RB	7808208	T15-D
Ø 20	5Nm	7808120	FS50615RB	7808209	T20-D
Ø 25	5Nm	7808121	FS60620RB	7808209	T20-D
Ø 30,32	6Nm	7808122	FS80624RB	7808212	T30-T

PFB SCREW FIT

Milling | Indexables

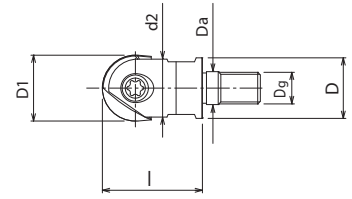

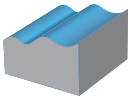

- Finishing ball nose cutter
- Excellent sharpness
- Screw fit type
- 10 - 30 mm



EDP	Body size	Designation	Z	D1	Dg		I	d2	D	Da	Price
7801490	③	PFB-R100SF6	2	10	6	7	26	9	9	6,5	
7801491	④	PFB-R120SF6	2	12	6	7	26	11	11	6,5	
7801492	⑤	PFB-R160SF8	2	16	8	10	32	14	14,5	8,5	
7801493	⑥	PFB-R200SF10	2	20	10	14	38	18	18	10,5	
7801494	⑦	PFB-R250SF12	2	25	12	17	38	22	23	12,5	
7801495	⑧	PFB-R300SF16	2	30	16	22	43	27	28	17	

Accessories & spare parts

Applicable cutter Ø	Tightening torque (recommended)		 Clamping screw		 Wrench	
Ø 6	0,8Nm		7808124	FS20652RB	7808203	T6-D
Ø 8	1Nm		7808123	FS25669RB	7808204	T7-D
Ø 10	1,2Nm		7808117	FS30686RB	7808205	T8-D
Ø 12	2Nm		7808118	FS35610RB	7808207	T10-D
Ø 16	3Nm		7808119	FS40613RB	7808208	T15-D
Ø 20	5Nm		7808120	FS50615RB	7808209	T20-D
Ø 25	5Nm		7808121	FS60620RB	7808209	T20-D
Ø 30,32	6Nm		7808122	FS80624RB	7808212	T30-T



PFB INSERTS

Milling | Indexables

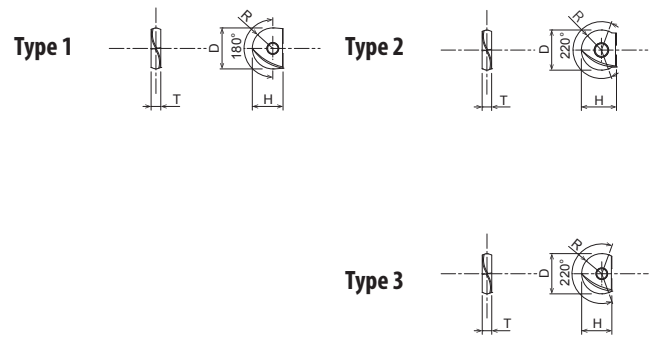

- Finishing ball nose cutter
- Excellent sharpness
- 6 - 32 mm

Type	EDP	Designation	Z	Range degree	Dc	R	T	H	Grade	P		M		K		N		S		H		Body size	Price
										dry	water	dry	water	GG	GGG	dry	water	dry	water	dry	water		
1	7820030	PFB080-SP	2	180°	8	4	2,4	7	XP3225	●		●				●						②	
1	7820031	PFB100-SP	2	180°	10	5	2,6	8,5	XP3225	●		●				●						③	
1	7820032	PFB120-SP	2	180°	12	6	3	10	XP3225	●		●				●						④	
1	7820033	PFB160-SP	2	180°	16	8	4	12	XP3225	●		●				●						⑤	
1	7820034	PFB200-SP	2	180°	20	10	5	15	XP3225	●		●				●						⑥	
1	7820035	PFB250-SP	2	180°	25	12,5	6	18,5	XP3225	●		●				●						⑦	
1	7820036	PFB300-SP	2	180°	30	15	7	22,5	XP3225	●		●				●						⑧	
1	7820010	PFB080-SP	2	180°	8	4	2,4	7	XP3320	○		○		○	○				●	○		②	
1	7820011	PFB100-SP	2	180°	10	5	2,6	8,5	XP3320	○		○		○	○				●	○		③	
1	7820012	PFB120-SP	2	180°	12	6	3	10	XP3320	○		○		○	○				●	○		④	
1	7820013	PFB160-SP	2	180°	16	8	4	12	XP3320	○		○		○	○				●	○		⑤	
1	7820014	PFB200-SP	2	180°	20	10	5	15	XP3320	○		○		○	○				●	○		⑥	
1	7820015	PFB250-SP	2	180°	25	12,5	6	18,5	XP3320	○		○		○	○				●	○		⑦	
1	7820016	PFB300-SP	2	180°	30	15	7	22,5	XP3320	○		○		○	○				●	○		⑧	
2	7820039	PFB060-SH	2	220°	6	3	2	5	XP3310					●	●						●	①	
1	7820040	PFB080-SH	2	180°	8	4	2,4	7	XP3310					●	●						●	②	
1	7820041	PFB100-SH	2	180°	10	5	2,6	8,5	XP3310					●	●						●	③	
1	7820042	PFB120-SH	2	180°	12	6	3	10	XP3310					●	●						●	④	
1	7820043	PFB160-SH	2	180°	16	8	4	12	XP3310					●	●						●	⑤	
1	7820044	PFB200-SH	2	180°	20	10	5	15	XP3310					●	●						●	⑥	
1	7820045	PFB250-SH	2	180°	25	12,5	6	18,5	XP3310					●	●						●	⑦	
1	7820046	PFB300-SH	2	180°	30	15	7	22,5	XP3310					●	●						●	⑧	
1	7820047	PFB320-SH	2	180°	32	16	7	23,5	XP3310					●	●						●	⑨	
2	7820018	PFB060-D	2	220°	6	3	2	5	XC4505							●						①	
2	7820019	PFB070-D	2	220°	7	3,5	2	5,5	XC4505							●						①	
1	7820020	PFB080-D	2	180°	8	4	2,4	7	XC4505							●						②	
1	7820021	PFB100-D	2	180°	10	5	2,6	8,5	XC4505							●						③	
1	7820022	PFB120-D	2	180°	12	6	3	10	XC4505							●						④	
1	7820023	PFB160-D	2	180°	16	8	4	12	XC4505							●						⑤	
1	7820024	PFB200-D	2	180°	20	10	5	15	XC4505							●						⑥	
1	7820025	PFB250-D	2	180°	25	12,5	6	18,5	XC4505							●						⑦	
1	7820026	PFB300-D	2	180°	30	15	7	22,5	XC4505							●						⑧	
2	7820048	PFB060-Q	2	220°	6	3	2	5	XP3225	●		●				●				○		①	
2	7820049	PFB070-Q	2	220°	7	3,5	2	5,5	XP3225	●		●				●				○		①	
2	7820050	PFB080-Q	2	220°	8	4	2,4	7	XP3225	●		●				●				○		②	
2	7820051	PFB100-Q	2	220°	10	5	2,6	8,5	XP3225	●		●				●				○		③	
2	7820052	PFB120-Q	2	220°	12	6	3	10	XP3225	●		●				●				○		④	
3	7820053	PFB160-Q	2	220°	16	8	4	12	XP3225	●		●				●				○		⑤	
3	7820054	PFB200-Q	2	220°	20	10	5	15	XP3225	●		●				●				○		⑥	
3	7820055	PFB250-Q	2	220°	25	12,5	6	18,5	XP3225	●		●				●				○		⑦	
3	7820056	PFB300-Q	2	220°	30	15	7	22,5	XP3225	●		●				●				○		⑧	

CUTTING CONDITIONS

Milling | Indexables | Cutting conditions

PFB-SP, PFB-SH, PFB-Q

Finishing ball nose cutter

	Work Material	Tensile Strength / Hardness	Milling Speed Vc (m/min)	Depth of Cut ap (mm)	Feed per Tooth fz (mm/t)			
					D			
					Ø 6,8	Ø 10,12	Ø 16,20	Ø 25-30-32
P	Mild Steel-Carbon Steel (S5400-S10C)	~180HB	300 (200~ 400)	0,02 D	0,1	0,12	0,14	0,18
	Carbon Steel-Alloy Steel (S50C-SCM440)	~280HB	300 (200~ 400)	0,02 D	0,07	0,1	0,12	0,14
	Die Steel (SKD11-SKD61)	~280HB	250 (150 ~ 350)	0,02 D	0,07	0,1	0,12	0,14
M	Stainless Steel (Dry) (SUS304-SUS420)	~250HB	250 (150 ~ 350)	0,02 D	0,07	0,12	0,14	0,17
K	Cast Iron (FC250)	~300N/mm ²	400 (300~ 500)	0,02 D	0,12	0,14	0,18	0,22
	Ductile Cast Iron (FCD400)	~600N/mm ²	300 (200~ 400)	0,02 D	0,1	0,12	0,14	0,18
N	Aluminium Alloy	~13% Si	500 (400~ 600)	0,03 D	0,12	0,14	0,18	0,22
	Copper Alloy (C1100)	-	300 (200 ~ 400)	0,03 D	0,11	0,13	0,17	0,22
S	Heat Resistant Alloys (Wet) (Inconel 718)	-	50 (25~ 80)	0,015 D	0,04	0,05	0,06	0,06
	Titanium Alloy (Wet) (Ti-Al-4V)	-	90 (40~120)	0,02 D	0,06	0,08	0,11	0,13
H	Pre-hardened Steel (NAK80, STAVAX)	40~43HRC	200 (100~ 300)	0,015 D	0,06	0,07	0,08	0,1
	Steel for Die Casting (DAC55-DH31)	43~48HRC	180 (90 ~ 200)	0,015 D	0,05	0,06	0,07	0,07
	Hardened Steel (SKD11)	50~60HRC	150 (100 ~ 250)	0,01 D	0,05	0,06	0,07	0,07

PFB-D

Finishing ball nose cutter

	Work Material	Tensile Strength / Hardness	Milling Speed Vc (m/min)	Depth of Cut ap (mm)	Feed per Tooth fz (mm/t)			
					D			
					Ø 6,8	Ø 10,12	Ø 16,20	Ø 25-30-32
N	Graphite	-	500 (400~ 600)	0,03 D	0,14	0,17	0,21	0,25
	CFRP Carbon Fiber Reinforced Plastic	-	300 (300 ~ 500)	0,03 D	0,11	0,13	0,17	0,20



CUTTING CONDITIONS

Milling | Indexables | Cutting conditions

PFB

Chart of cutting depth and actual cutting diameter

Depth of cut		Actual cutting diameter														
D	R	0,1	0,2	0,3	0,4	0,5	0,8	1	1,5	2	2,5	3	3,5	4	4,5	5
6	3	1,5	2,2	2,6	3	3,3	4,1	-	-	-	-	-	-	-	-	-
7	3,5	1,6	2,3	2,8	3,3	3,6	4,5	-	-	-	-	-	-	-	-	-
8	4	1,8	2,5	3	3,5	3,9	4,8	-	-	-	-	-	-	-	-	-
10	5	2	2,8	3,4	3,9	4,4	5,4	6	7,1	-	-	-	-	-	-	-
12	6	2,2	3,1	3,7	4,3	4,8	6	6,6	7,9	8,9	-	-	-	-	-	-
16	8	2,5	3,6	4,3	5	5,6	7	7,7	9,3	10,6	11,6	-	-	-	-	-
20	10	2,8	4	4,9	5,6	6,2	7,8	8,7	10,5	12	13,2	14,3	15,2	-	-	-
25	12,5	3,2	4,5	5,4	6,3	7	8,8	9,8	11,9	13,6	15	16,2	17,3	18,3	-	-
30	15	3,5	4,9	6	6,9	7,7	9,7	10,8	13,1	15	16,6	18	19,3	20,4	21,4	22,4
32	16	3,6	5	6,2	7,1	7,9	10	11,1	13,5	15,5	17,2	18,7	20	21,2	22,2	23,2

How to determine actual cutting diameter D

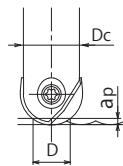

$$D = 2 \sqrt{ap(Dc - ap)}$$

Recommended pick feed and milling surface roughness

	Unit: mm									
Pf	0,4	0,45	0,5	0,6	0,7	0,8	1	1,2	1,3	1,4
h	0,007	0,007	0,008	0,009	0,01	0,01	0,012	0,014	0,014	0,015

Theoretical milling surface roughness

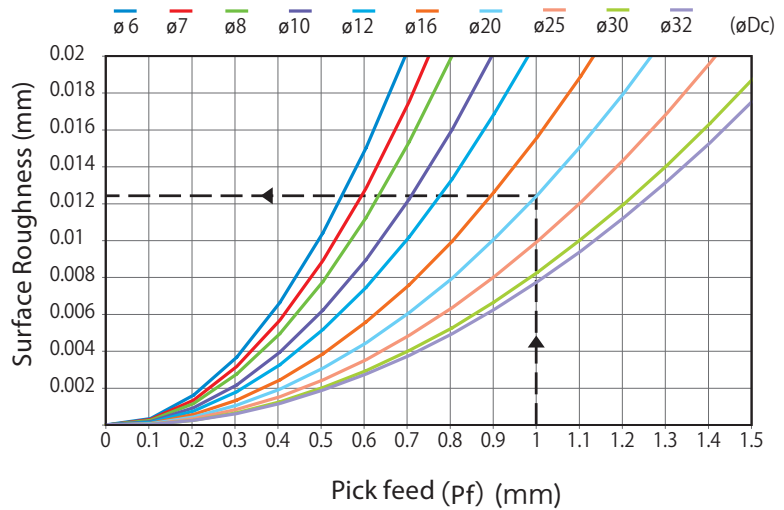
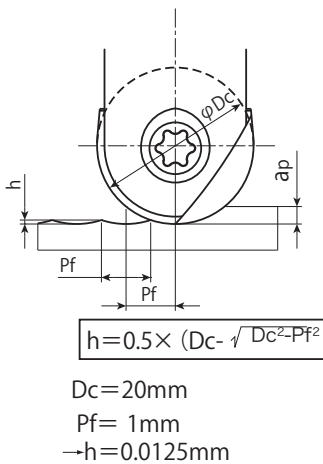

CUTTING CONDITIONS

Milling | Indexables | Cutting conditions

PFB

Finish Ball nose cutter

Surface Finish - PFB

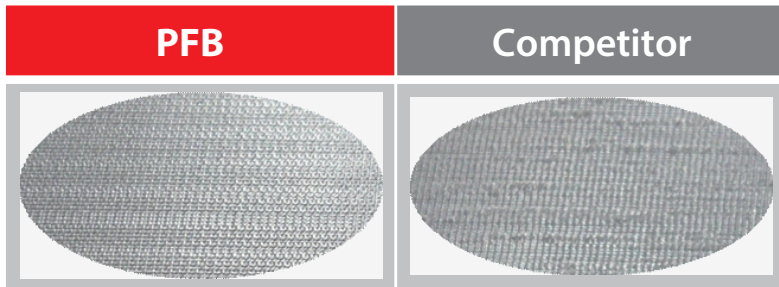

Machining Detail		Machining Parameters	
Size	R10	Name of Part	Sample model
Overhang	80mm	Material	S50C
Speed	8,000min ⁻¹	Machining Method	Copy Milling
Feed	3,200mm/min	Machining Type	Horizontal Machine
ap	0.3mm	Holder Size	BT50
Pf	0.3mm	Coolant Size	Water Soluble

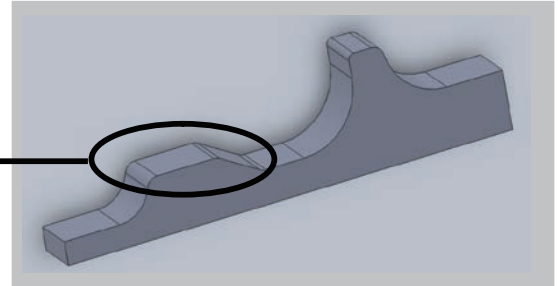

Machining Method	Product	2	4	6	8	10 (µm)	RZ (µm)
Copy Milling Flat Surface	PFB	[Bar chart showing RZ values for PFB]					6,171
	A	[Bar chart showing RZ values for Product A]					10,93
	B	[Bar chart showing RZ values for Product B]					6,021
	C	[Bar chart showing RZ values for Product C]					7,798
	D	[Bar chart showing RZ values for Product D]					6,963
Machining Method	Product	0.5	1	1.5	2	2.5 (µm)	RZ (µm)
Copy Milling Slanted Surface	PFB	[Bar chart showing RZ values for PFB]					1,967
	A	[Bar chart showing RZ values for Product A]					2,098
	B	[Bar chart showing RZ values for Product B]					2,083
	C	[Bar chart showing RZ values for Product C]					2,541
	D	[Bar chart showing RZ values for Product D]					1,827
Machining Method	Product	0.5	1	1.5	2	2.5 (µm)	RZ (µm)
Copy Milling Radial Surface	PFB	[Bar chart showing RZ values for PFB]					1,98
	A	[Bar chart showing RZ values for Product A]					1,9
	B	[Bar chart showing RZ values for Product B]					2,183
	C	[Bar chart showing RZ values for Product C]					2
	D	[Bar chart showing RZ values for Product D]					2,508

Comparison of tool wear - PFB

Machining Detail		Machining Parameters	
Size	R10	Name of Part	Blade
Overhang	110mm	Material	SUH600
Speed	1,500min ⁻¹	Machining Method	Copy Milling
Feed	2,000mm/min	Machining Type	Vertical Machining Center
ap	0.2mm	Holder Size	BT40
Pf	1mm	Coolant Size	Water Soluble

Top surface R300

Machined Time	70 minutes		140 minutes	
Machined Length	100m		200m	
PFB	[Microscopic images of PFB at 70m]		[Microscopic images of PFB at 140m]	
	Wear (mm)	0.033	0.030	0.041
Competitor	[Microscopic images of Competitor at 70m]		[Microscopic images of Competitor at 140m]	
	Wear (mm)	0.032	0.033	0.070

Comparison of tool wear after 200M of machining

Milling | Indexables

Cutting conditions

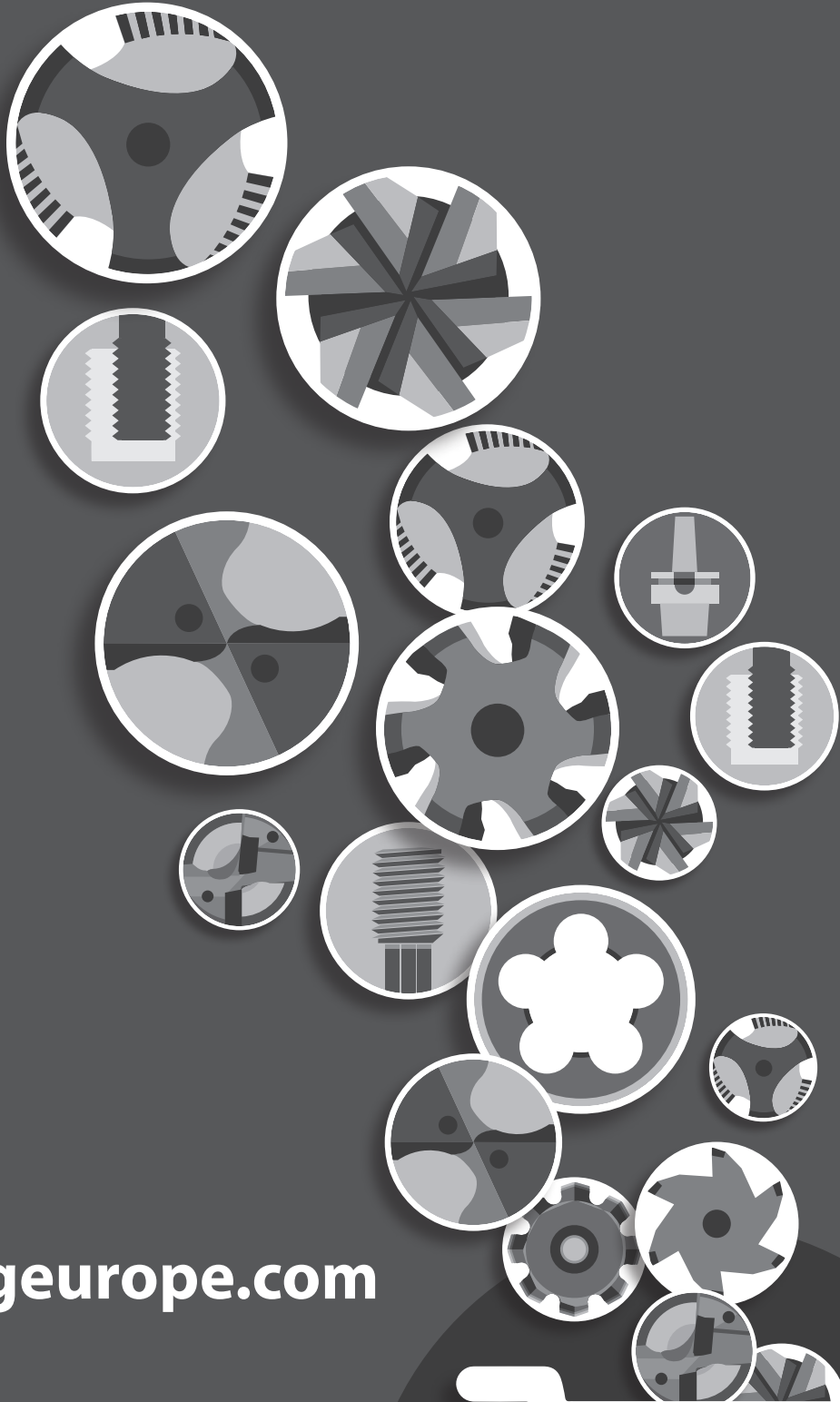

www.osgeurope.com



Features: PHOENIX PFR

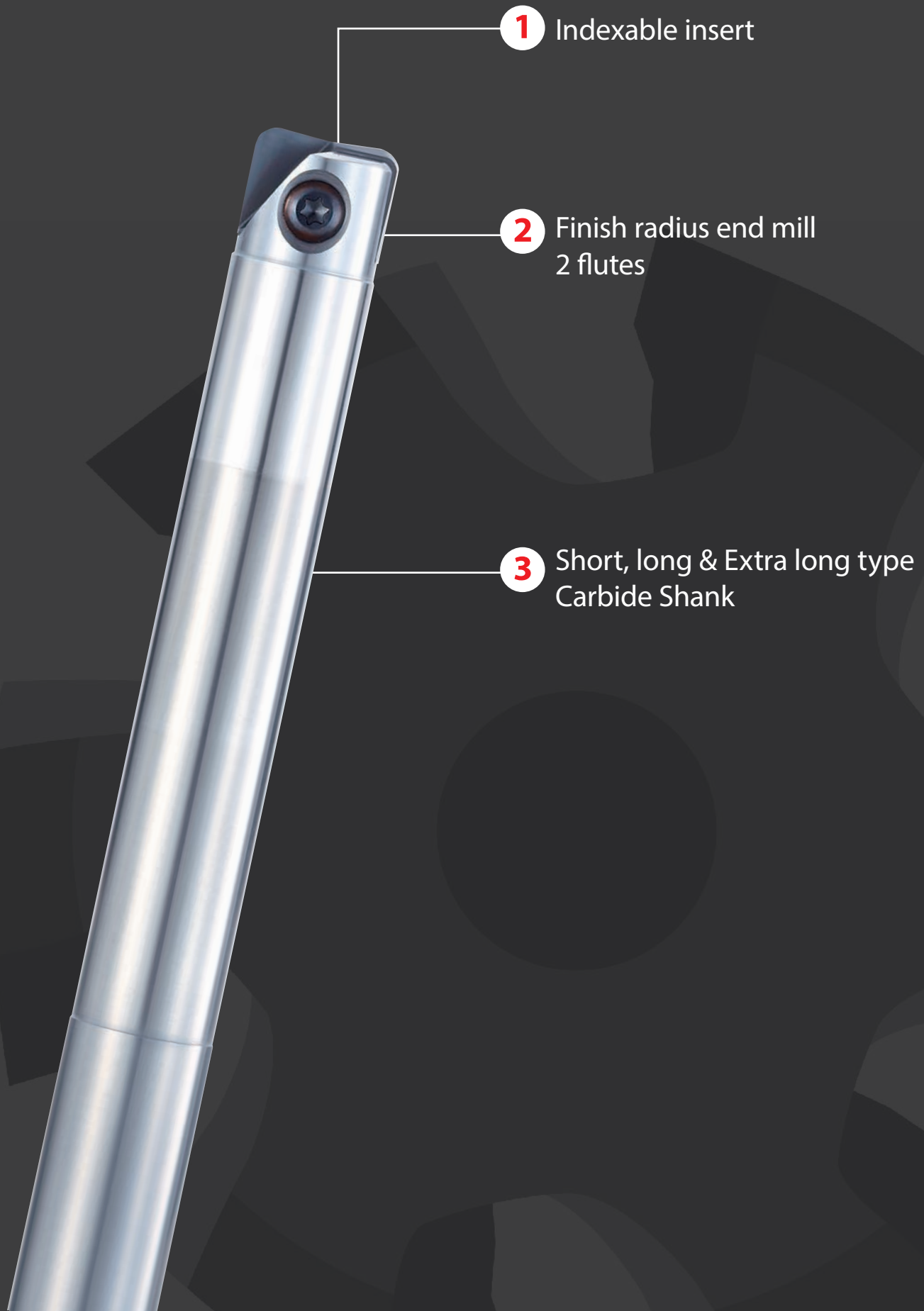

PFR INSERTS

Milling | Indexables

Beautifully finished surfaces

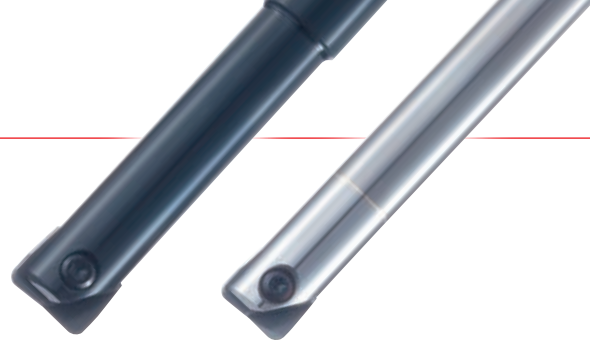

With the advanced grinding technology, PFR inserts have high dimensional accuracy and flat drag on the end cutting edge. It enables outstanding machining precision and finished surface.

- $\pm 8\mu\text{m}$ Corner radius precision: $\pm 8\mu\text{m}$
- $0\sim-0,020\text{mm}$ Tolerance for outer diameter : -0.020 mm

Finished surface roughness curve

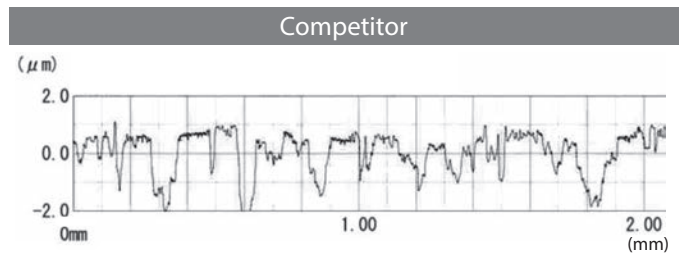
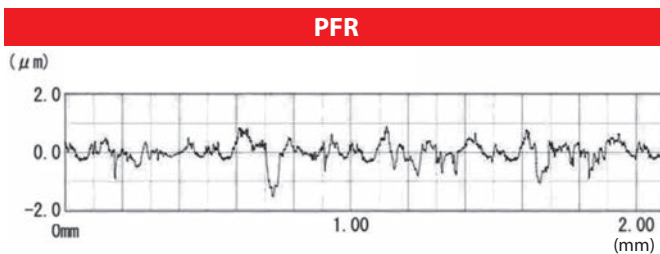

Three types of insert are available. All inserts are specially processed

PFR-ST

- Applicable to a wide variety of work materials from mild steel to hardened steel
- Ideal for milling with long overhangs ($L/D \geq 5$)
- Positive rake angle with excellent sharpness and bite

XP3225 Grade

- For stable milling of a wide variety of work materials
- Excellent lubricity and wear resistance

PFR-SH

- For milling cast iron, ductile iron and hardened steel
- High rigid cutting edge with two-dimensional negative chamfer, which is applicable to unstable machining conditions
- Highly resistant carbide material

XP3310 Grade

- Ideal for dry milling of high hardened steel and cast iron
- Excellent heat resistance and wear resistance

PFR-D

- Sharp cutting edge specialized for milling graphite
- Highly adhesive carbide material for diamond coating

XC4505 Grade

- For milling nonferrous material
- Optimal diamond coating for milling graphite



PROCESSING DATA

Milling | Indexables

PX5 (33HRC) Side and Bottom finish for PX5 (pre-hardened steel)

Tool	PFR-R250SS25-LL260CS
Insert (grade)	PFR250R20-ST (XP3225)
Work Material	PX5 (33HRC)
Cutting Speed	82m/min(1,050min ⁻¹)
Feed	500mm/min(0.24mm/t)
Depth of Cut	$a_p=0.5\text{mm}$ $a_e=0.5\sim 1\text{mm}$
Coolant	Water Soluble
Machine	Horizontal Machining Center (BT50)

PFR enabled high precision machining as well as solid carbide tool. With the sharper cutting edge than conventional tools, PFR could be operated stably with deeper depth of cut. As a result, machining time was shortened by reducing semi-finishing process.

Examples from users Machined workpiece: die insert

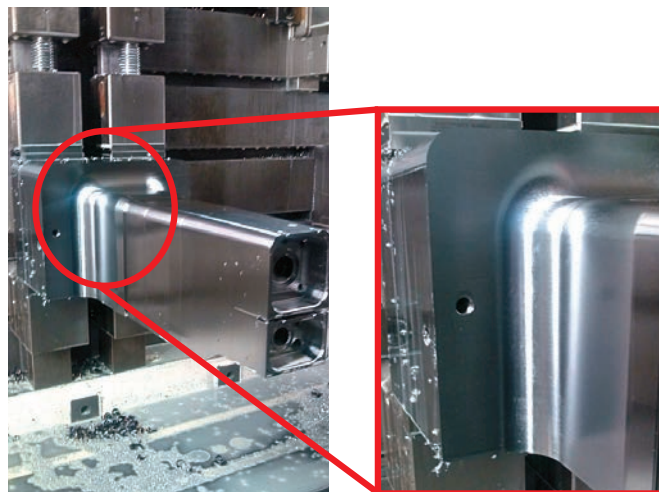

State of damage to blade edge after 88 m (three hours) of machining on a workpiece

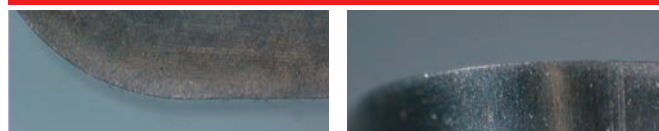

● Rake

● Flank

Side and Bottom finish for plastic mold steel

Tool	PFB-R200SS20-LL240CS	
Insert (grade)	PFR200R10-ST (XP3225)	
Work Material	SD18 (JIS S55C)	
Cutting Speed	Side finish section 330m/min(5.250min ⁻¹)	Bottom finish section 100m/min(1.600min ⁻¹)
Feed	2,100mm/min(0,2mm/t)	400mm/min(0,125mm/t)
Depth of Cut	$a_p=1,5\text{mm}$ $a_e=0,05\sim 0,3\text{mm}$	$a_p=0,15\text{mm}$ Semi-finish $a_p=0,05\text{mm}$ Final finish
Coolant	Air Blow	
Machine	Vertical Machining Center (HSK A100)	

With the conventional tool, one insert for semi-finishing and another insert for finishing were consumed. With PFR, one insert could be last until the final finishing process. Furthermore, better finished surface was achieved.

Examples from users

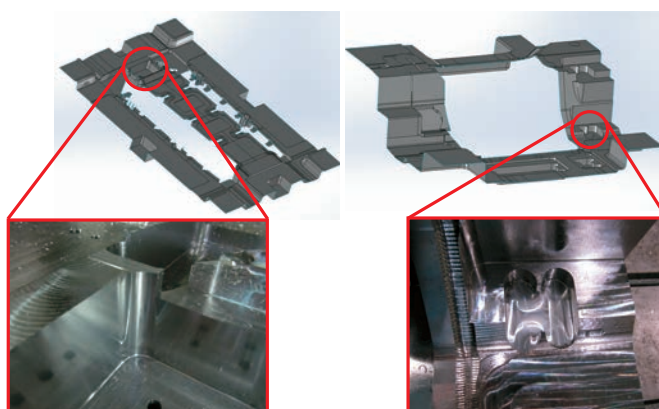

State of damage after total machining process (90 min)

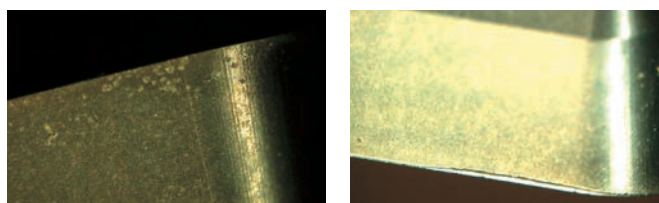

The tip shows normal wear, and there is no chipping despite the long overhang length.

PROCESSING DATA

Milling | Indexables

FCD600 Durability performance evaluation

Tool	PFR-R200SS20-S160
Insert (grade)	PFR200R10-SH (XP3310)
Work Material	FCD600
Cutting Speed	200m/min(3.200min ⁻¹)
Feed	1.280mm/min(0,2mm/t)
Depth of Cut	a _p =1mm a _e =2mm
Coolant	Air Blow
Machine	Horizontal Machining Center (BT40)

PFR enabled stable machining, and the wear progress had been slow since the early stage.

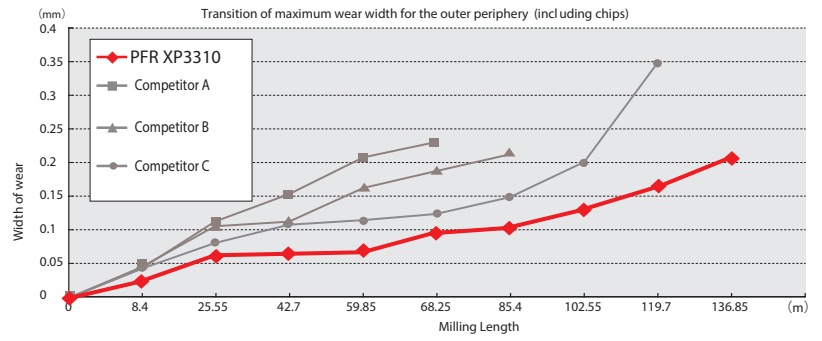

DH31(48HRC) Durability performance evaluation

Tool	PFR-R200SS20-S160
Insert (grade)	PFR200R10-SH (XP3310)
Work Material	DH31(48HRC)
Cutting Speed	60m/min(955min ⁻¹)
Feed	191mm/min(0.1mm/t)
Depth of Cut	a _p =0.5mm a _e =1mm
Coolant	Water Soluble
Machine	Horizontal Machining Center (BT40)

With the special chamfer on the cutting edge, PFR's insert XP3310 have a high chipping resistance. It enabled stable operation in machining hot work tool steel.

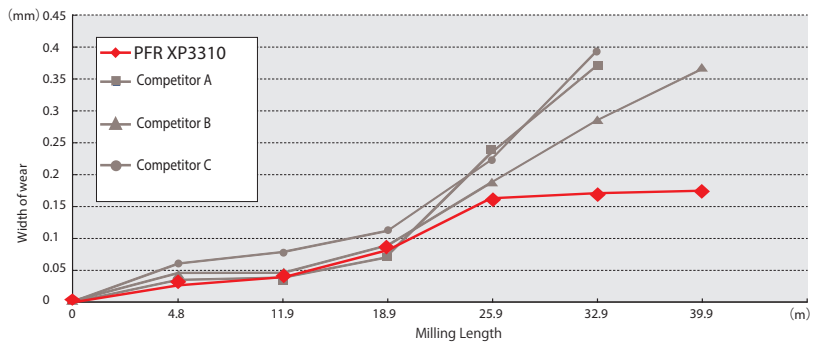

State of damage after 32.9 m of machining

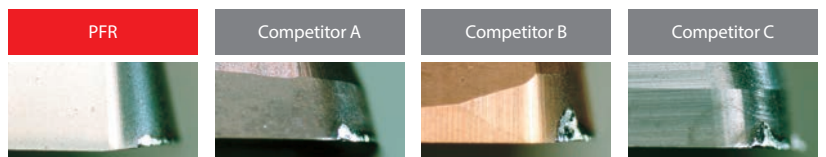

S50C Durability performance evaluation

Tool	PFR-R200SS20-S160
Insert (grade)	PFR200R10-ST (XP3225)
Work Material	S50C
Cutting Speed	200m/min(3,200min ⁻¹)
Feed	1,280mm/min(0.2mm/t)
Depth of Cut	a _p =0.1mma _e =2mm
Coolant	Water Soluble
Machine	Horizontal Machining Center (BT40)

Competitor products showed significant wear when exceeding 43m of milling length. PFR's insert XP3225, however, showed only little wear even after 140m length and remained good.

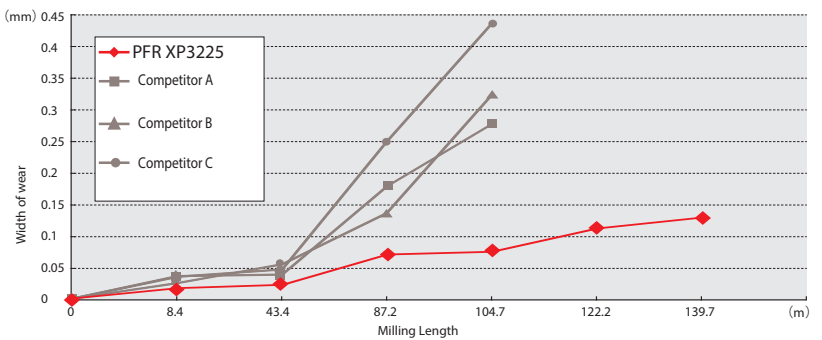

State of damage after 104.7 m of machining

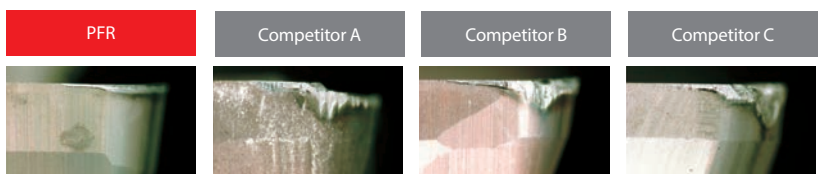



PROCESSING DATA

Milling | Indexables

PFR-D Field data of machining graphite electrode

Tool	PFR-R200SS20-S160CS
Insert (grade)	PFR200R20-D (XC4505)
Work Material	Graphite
Cutting Speed	125m/min(2.000min ⁻¹)
Feed	1.000mm/min(0,25mm/t)
Milling Method	Contour Milling
Depth of Cut	$a_p=1\text{mm}$ $a_e=0,5\text{mm}$
Coolant	None
Machine	Vertical Graphite Milling Machine (BT40)

	Peripheral Cutting Edge	End Teeth	Rake angle
State of damage after 17 hours of machining			
(mm) Frank wear	0,049	0,021	

PFR-D achieved fair finishing surface accuracy versus the competition.
Also machining cost was reduced by applying PFB instead of using solid carbide end mills.



PFR-D Field data of machining die cast mold

Tool	PFR-R160SS-S140CS
Insert (grade)	PFR160R10-D (XC4505)
Work Material	Graphite
Overhang Length	50mm (2,5D)
Cutting Speed	135m/min(2,700min ⁻¹)
Feed	3.330mm/min(0.62mm/t)
Milling Method	Contour Milling
Depth of Cut	$a_p=0,22\sim 0,5\text{mm}$ $a_e=2\sim 8\text{mm}$
Coolant	None
Machine	Vertical Machining center (BT40)

	Peripheral Cutting Edge	End Teeth	Rake angle
State of damage after 10 hours of machining			
(mm) Frank wear	0,062	0,087	

After finish machining of 10 hours, cutting edge was in good shape with normal wear. No abnormal peel off of coating was found. By applying PFR-D, machining time was drastically reduced versus the competitor's diamond coated ball end mill.

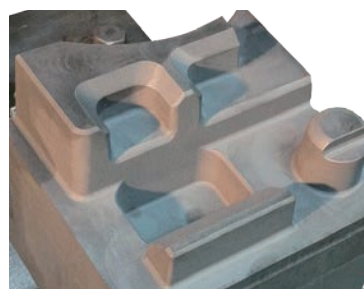

Shape of Test Piece

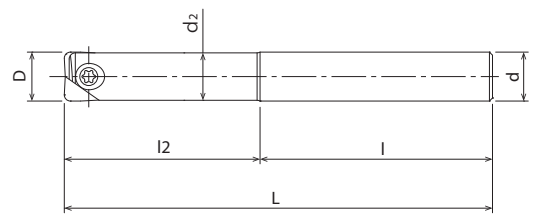

- Finishing corner radius cutter
- Excellent sharpness
- Cylindrical type
- 6 - 32 mm

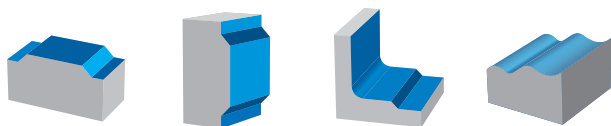

EDP	Body size	Designation	Z	D	L	l2	l2/D	l	L	d2	Specification	Price
7832029	①	PFR-R060SS06-S80CS	2	6	80	15	2,5	6	65	5,4	Carbide	
7832039	①	PFR-R060SS06-L100CS	2	6	100	30	5	6	70	5,4	Carbide	
7832019	①	PFR-R060SS06-LL120CS	2	6	120	42	7	6	78	5,4	Carbide	
7832030	②	PFR-R080SS08-S100CS	2	8	100	20	2,5	8	80	7,5	Carbide	
7832040	②	PFR-R080SS08-L120CS	2	8	120	40	5	8	80	7,5	Carbide	
7832020	②	PFR-R080SS08-LL140CS	2	8	140	56	7	8	84	7,5	Carbide	
7832031	③	PFR-R100SS10-S100CS	2	10	100	25	2,5	10	75	9,5	Carbide	
7832041	③	PFR-R100SS10-L130CS	2	10	130	50	5	10	80	9,5	Carbide	
7832021	③	PFR-R100SS10-LL150CS	2	10	150	70	7	10	80	9,5	Carbide	
7832032	④	PFR-R120SS12-S110CS	2	12	110	30	2,5	12	80	11,5	Carbide	
7832042	④	PFR-R120SS12-L140CS	2	12	140	60	5	12	80	11,5	Carbide	
7832022	④	PFR-R120SS12-LL160CS	2	12	160	84	7	12	76	11,5	Carbide	
7832033	⑤	PFR-R160SS16-S140CS	2	16	140	40	2,5	16	100	15,5	Carbide	
7832043	⑤	PFR-R160SS16-L160CS	2	16	160	72	4,5	16	88	15,5	Carbide	
7832023	⑤	PFR-R160SS16-LL200CS	2	16	200	96	6	16	104	15,5	Carbide	
7832034	⑥	PFR-R200SS20-S160CS	2	20	160	50	2,5	20	110	19,5	Carbide	
7832044	⑥	PFR-R200SS20-L180CS	2	20	180	90	4,5	20	90	19,5	Carbide	
7832024	⑥	PFR-R200SS20-LL240CS	2	20	240	120	6	20	120	19,5	Carbide	
7832035	⑦	PFR-R250SS25-S160CS	2	25	160	62,5	2,5	25	97,5	24,5	Carbide	
7832045	⑦	PFR-R250SS25-L200CS	2	25	200	100	4	25	100	24,5	Carbide	
7832025	⑦	PFR-R250SS25-LL260CS	2	25	260	137,5	5,5	25	122,5	24,5	Carbide	
7832036	⑧	PFR-R300SS32-S170CS	2	30	170	75	2,5	32	95	29,5	Carbide	
7832046	⑧	PFR-R300SS32-L220CS	2	30	220	120	4	32	100	29,5	Carbide	
7832026	⑧	PFR-R300SS32-LL290CS	2	30	290	165	5,5	32	125	29,5	Carbide	
7832037	⑨	PFR-R320SS32-S180CS	2	32	180	80	2,5	32	100	31,5	Carbide	
7832047	⑨	PFR-R320SS32-L230CS	2	32	230	128	4	32	102	31,5	Carbide	
7832027	⑨	PFR-R320SS32-LL300CS	2	32	300	176	5,5	32	124	31,5	Carbide	
7832000	②	PFR-R080SS08-S120	2	8	120	36	4,5	8	84	7,5	Steel	
7832001	③	PFR-R100SS10-S130	2	10	130	45	4,5	10	85	9,5	Steel	
7832002	④	PFR-R120SS12-S130	2	12	130	54	4,5	12	76	11,5	Steel	
7832003	⑤	PFR-R160SS16-S140	2	16	140	64	4	16	76	15,5	Steel	
7832004	⑥	PFR-R200SS20-S160	2	20	160	80	4	20	80	19,5	Steel	
7832005	⑦	PFR-R250SS25-S160	2	25	160	75	3	25	85	24,5	Steel	
7832006	⑧	PFR-R300SS32-S170	2	30	170	90	3	32	80	29,5	Steel	
7832007	⑨	PFR-R320SS32-S180	2	32	180	96	3	32	84	31,5	Steel	

Accessories & spare parts

Applicable cutter Ø	Tightening torque (recommended)	Clamping screw		Wrench	
		Clamping screw	Wrench	Clamping screw	Wrench
Ø 6	0.8Nm	7808124	FS20652RB	7808203	T6-D
Ø 8	1Nm	7808123	FS25669RB	7808204	T7-D
Ø 10	1.2Nm	7808117	FS30686RB	7808205	T8-D
Ø 12	2Nm	7808118	FS35610RB	7808207	T10-D
Ø 16	3Nm	7808119	FS40613RB	7808208	T15-D
Ø 20	5Nm	7808120	FS50615RB	7808209	T20-D
Ø 25	5Nm	7808121	FS60620RB	7808209	T20-D
Ø 30, 32	6Nm	7808122	FS80624RB	7808212	T30-T



PFR SCREW FIT

Milling | Indexables

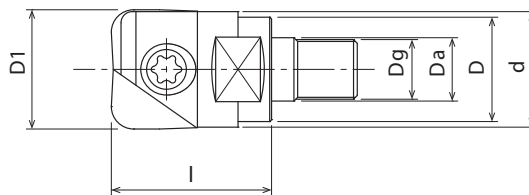

- Finishing corner radius cutter
- Excellent sharpness
- Screw fit type
- 10 - 32 mm

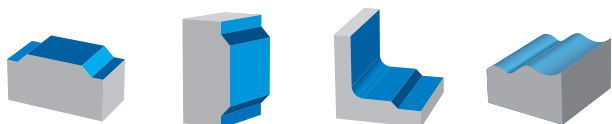

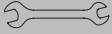

EDP	Body size	Designation	Z	D1	Dg		I	d	D	Da	Price
7832090	③	PFR-R100SF6	2	10	6	7	26	9	9	6,5	
7832091	④	PFR-R120SF6	2	12	6	7	26	11	11	6,5	
7832092	⑤	PFR-R160SF8	2	16	8	10	32	15	14,5	8,5	
7832093	⑥	PFR-R200SF10	2	20	10	14	38	19	18	10,5	
7832094	⑦	PFR-R250SF12	2	25	12	17	38	24	23	12,5	
7832095	⑧	PFR-R300SF16	2	30	16	22	43	29	28	17	
7832096	⑨	PFR-R320SF16	2	32	16	22	43	31	28	17	

Milling | Indexables



Accessories & spare parts

Applicable cutter Ø	Tightening torque (recommended)		 Clamping screw		 Wrench	
Ø 6	0.8Nm		7808124	FS20652RB	7808203	T6-D
Ø 8	1Nm		7808123	FS25669RB	7808204	T7-D
Ø 10	1.2Nm		7808117	FS30686RB	7808205	T8-D
Ø 12	2Nm		7808118	FS35610RB	7808207	T10-D
Ø 16	3Nm		7808119	FS40613RB	7808208	T15-D
Ø 20	5Nm		7808120	FS50615RB	7808209	T20-D
Ø 25	5Nm		7808121	FS60620RB	7808209	T20-D
Ø 30, 32	6Nm		7808122	FS80624RB	7808212	T30-T

PFR INSERTS

Milling | Indexables

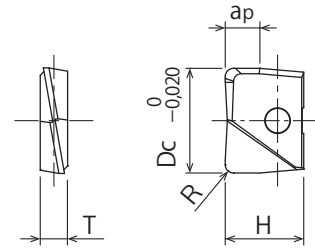
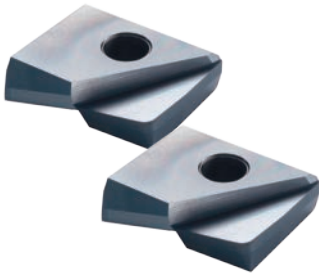

- Finishing corner radius cutter
- Excellent sharpness
- 6 - 32 mm

EDP	Designation	Z	Dc	R	T	H	ap	Grade	P		M		K		N		S		H		Body size	Price
									dry	☼	dry	☼	GG	GGG	dry	☼	dry	☼	dry	☼		
7820235	PFR320R10-ST	2	32	1	7	23,5	10,3	XP3225	☼	☼	☼	☼	☼	☼	☼						9	
7820236	PFR320R20-ST	2	32	2	7	23,5	10,3	XP3225	☼	☼	☼	☼	☼	☼	☼						9	
7820237	PFR320R30-ST	2	32	3	7	23,5	10,3	XP3225	☼	☼	☼	☼	☼	☼	☼						9	
7820400	PFR060R03-SH	2	6	0,3	2	5	2	XP3310	☼	☼	☼	☼	☼	☼							1	
7820401	PFR060R05-SH	2	6	0,5	2	5	2	XP3310	☼	☼	☼	☼	☼	☼							1	
7820402	PFR060R10-SH	2	6	1	2	5	2	XP3310	☼	☼	☼	☼	☼	☼							1	
7820403	PFR070R03-SH	2	7	0,3	2	5,5	2	XP3310	☼	☼	☼	☼	☼	☼							1	
7820404	PFR070R05-SH	2	7	0,5	2	5,5	2	XP3310	☼	☼	☼	☼	☼	☼							1	
7820405	PFR070R10-SH	2	7	1	2	5,5	2	XP3310	☼	☼	☼	☼	☼	☼							1	
7820250	PFR080R03-SH	2	8	0,3	2,4	7	2,7	XP3310	☼	☼	☼	☼	☼	☼							2	
7820251	PFR080R05-SH	2	8	0,5	2,4	7	2,7	XP3310	☼	☼	☼	☼	☼	☼							2	
7820252	PFR080R10-SH	2	8	1	2,4	7	2,7	XP3310	☼	☼	☼	☼	☼	☼							2	
7820253	PFR080R20-SH	2	8	2	2,4	7	2,7	XP3310	☼	☼	☼	☼	☼	☼							2	
7820254	PFR100R03-SH	2	10	0,3	2,6	8,5	3,3	XP3310	☼	☼	☼	☼	☼	☼							3	
7820255	PFR100R05-SH	2	10	0,5	2,6	8,5	3,3	XP3310	☼	☼	☼	☼	☼	☼							3	
7820256	PFR100R10-SH	2	10	1	2,6	8,5	3,3	XP3310	☼	☼	☼	☼	☼	☼							3	
7820257	PFR100R20-SH	2	10	2	2,6	8,5	3,3	XP3310	☼	☼	☼	☼	☼	☼							3	
7820406	PFR110R03-SH	2	11	0,3	2,6	8,5	3,3	XP3310	☼	☼	☼	☼	☼	☼							3	
7820407	PFR110R05-SH	2	11	0,5	2,6	8,5	3,3	XP3310	☼	☼	☼	☼	☼	☼							3	
7820408	PFR110R10-SH	2	11	1	2,6	8,5	3,3	XP3310	☼	☼	☼	☼	☼	☼							3	
7820409	PFR110R20-SH	2	11	2	2,6	8,5	3,3	XP3310	☼	☼	☼	☼	☼	☼							3	
7820258	PFR120R03-SH	2	12	0,3	3	10	4	XP3310	☼	☼	☼	☼	☼	☼							4	
7820259	PFR120R05-SH	2	12	0,5	3	10	4	XP3310	☼	☼	☼	☼	☼	☼							4	
7820260	PFR120R10-SH	2	12	1	3	10	4	XP3310	☼	☼	☼	☼	☼	☼							4	
7820261	PFR120R20-SH	2	12	2	3	10	4	XP3310	☼	☼	☼	☼	☼	☼							4	
7820262	PFR120R30-SH	2	12	3	3	10	4	XP3310	☼	☼	☼	☼	☼	☼							4	
7820410	PFR130R03-SH	2	13	0,3	3	10	4	XP3310	☼	☼	☼	☼	☼	☼							4	
7820411	PFR130R05-SH	2	13	0,5	3	10	4	XP3310	☼	☼	☼	☼	☼	☼							4	
7820412	PFR130R10-SH	2	13	1	3	10	4	XP3310	☼	☼	☼	☼	☼	☼							4	
7820413	PFR130R20-SH	2	13	2	3	10	4	XP3310	☼	☼	☼	☼	☼	☼							4	
7820263	PFR160R03-SH	2	16	0,3	4	12	5,3	XP3310	☼	☼	☼	☼	☼	☼							5	
7820264	PFR160R05-SH	2	16	0,5	4	12	5,3	XP3310	☼	☼	☼	☼	☼	☼							5	
7820265	PFR160R10-SH	2	16	1	4	12	5,3	XP3310	☼	☼	☼	☼	☼	☼							5	
7820266	PFR160R20-SH	2	16	2	4	12	5,3	XP3310	☼	☼	☼	☼	☼	☼							5	
7820267	PFR160R30-SH	2	16	3	4	12	5,3	XP3310	☼	☼	☼	☼	☼	☼							5	
7820414	PFR170R03-SH	2	17	0,3	4	12	5,3	XP3310	☼	☼	☼	☼	☼	☼							5	
7820415	PFR170R05-SH	2	17	0,5	4	12	5,3	XP3310	☼	☼	☼	☼	☼	☼							5	
7820416	PFR170R10-SH	2	17	1	4	12	5,3	XP3310	☼	☼	☼	☼	☼	☼							5	
7820417	PFR170R20-SH	2	17	2	4	12	5,3	XP3310	☼	☼	☼	☼	☼	☼							5	
7820268	PFR200R03-SH	2	20	0,3	5	15	6,7	XP3310	☼	☼	☼	☼	☼	☼							6	
7820269	PFR200R05-SH	2	20	0,5	5	15	6,7	XP3310	☼	☼	☼	☼	☼	☼							6	
7820270	PFR200R10-SH	2	20	1	5	15	6,7	XP3310	☼	☼	☼	☼	☼	☼							6	
7820271	PFR200R20-SH	2	20	2	5	15	6,7	XP3310	☼	☼	☼	☼	☼	☼							6	
7820272	PFR200R30-SH	2	20	3	5	15	6,7	XP3310	☼	☼	☼	☼	☼	☼							6	
7820418	PFR210R03-SH	2	21	0,3	5	15	6,7	XP3310	☼	☼	☼	☼	☼	☼							6	
7820419	PFR210R05-SH	2	21	0,5	5	15	6,7	XP3310	☼	☼	☼	☼	☼	☼							6	
7820420	PFR210R10-SH	2	21	1	5	15	6,7	XP3310	☼	☼	☼	☼	☼	☼							6	
7820421	PFR210R20-SH	2	21	2	5	15	6,7	XP3310	☼	☼	☼	☼	☼	☼							6	
7820273	PFR250R03-SH	2	25	0,3	6	18,5	8,3	XP3310	☼	☼	☼	☼	☼	☼							7	
7820274	PFR250R05-SH	2	25	0,5	6	18,5	8,3	XP3310	☼	☼	☼	☼	☼	☼							7	
7820275	PFR250R10-SH	2	25	1	6	18,5	8,3	XP3310	☼	☼	☼	☼	☼	☼							7	
7820276	PFR250R20-SH	2	25	2	6	18,5	8,3	XP3310	☼	☼	☼	☼	☼	☼							7	
7820277	PFR250R30-SH	2	25	3	6	18,5	8,3	XP3310	☼	☼	☼	☼	☼	☼							7	
7820422	PFR260R03-SH	2	26	0,3	6	18,5	8,3	XP3310	☼	☼	☼	☼	☼	☼							7	
7820423	PFR260R05-SH	2	26	0,5	6	18,5	8,3	XP3310	☼	☼	☼	☼	☼	☼							7	
7820424	PFR260R10-SH	2	26	1	6	18,5	8,3	XP3310	☼	☼	☼	☼	☼	☼							7	
7820425	PFR260R20-SH	2	26	2	6	18,5	8,3	XP3310	☼	☼	☼	☼	☼	☼							7	
7820278	PFR300R03-SH	2	30	0,3	7	22,5	10	XP3310	☼	☼	☼	☼	☼	☼							8	
7820279	PFR300R05-SH	2	30	0,5	7	22,5	10	XP3310	☼	☼	☼	☼	☼	☼							8	
7820280	PFR300R10-SH	2	30	1	7	22,5	10	XP3310	☼	☼	☼	☼	☼	☼							8	
7820281	PFR300R20-SH	2	30	2	7	22,5	10	XP3310	☼	☼	☼	☼	☼	☼							8	



PFR INSERTS

Milling | Indexables

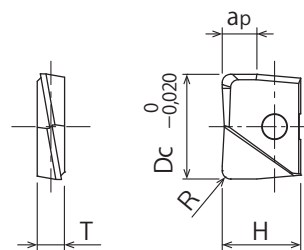
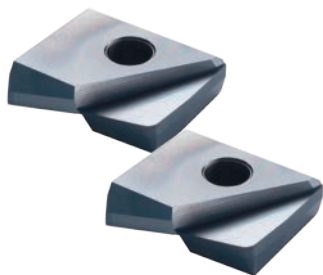

- Finishing corner radius cutter
- Excellent sharpness
- 6 - 32 mm

EDP	Designation	Z	Dc	R	T	H	ap	Grade	P		M		K		N		S		H		Body size	Price		
									dry	⊖	dry	⊖	GG	GGG	dry	⊖	dry	⊖	dry	⊖				
7820282	PFR300R30-SH	2	30	3	7	22,5	10	XP3310	⊖		⊖		●	●							●		⑧	
7820283	PFR320R03-SH	2	32	0,3	7	23,5	10,3	XP3310	⊖		⊖		●	●							●		⑨	
7820284	PFR320R05-SH	2	32	0,5	7	23,5	10,3	XP3310	⊖		⊖		●	●							●		⑨	
7820285	PFR320R10-SH	2	32	1	7	23,5	10,3	XP3310	⊖		⊖		●	●							●		⑨	
7820286	PFR320R20-SH	2	32	2	7	23,5	10,3	XP3310	⊖		⊖		●	●							●		⑨	
7820287	PFR320R30-SH	2	32	3	7	23,5	10,3	XP3310	⊖		⊖		●	●							●		⑨	
7820450	PFR060R03-D	2	6	0,3	2	5	2	XC4505							●								①	
7820451	PFR060R05-D	2	6	0,5	2	5	2	XC4505							●								①	
7820452	PFR060R10-D	2	6	1	2	5	2	XC4505							●								①	
7820300	PFR080R03-D	2	8	0,3	2,4	7	2,7	XC4505							●								②	
7820301	PFR080R05-D	2	8	0,5	2,4	7	2,7	XC4505							●								②	
7820302	PFR080R10-D	2	8	1	2,4	7	2,7	XC4505							●								②	
7820303	PFR100R03-D	2	10	0,3	2,6	8,5	3,3	XC4505							●								③	
7820304	PFR100R05-D	2	10	0,5	2,6	8,5	3,3	XC4505							●								③	
7820305	PFR100R10-D	2	10	1	2,6	8,5	3,3	XC4505							●								③	
7820306	PFR120R03-D	2	12	0,3	3	10	4	XC4505							●								④	
7820307	PFR120R05-D	2	12	0,5	3	10	4	XC4505							●								④	
7820308	PFR120R10-D	2	12	1	3	10	4	XC4505							●								④	
7820309	PFR160R03-D	2	16	0,3	4	12	5,3	XC4505							●								⑤	
7820310	PFR160R05-D	2	16	0,5	4	12	5,3	XC4505							●								⑤	
7820311	PFR160R10-D	2	16	1	4	12	5,3	XC4505							●								⑤	
7820312	PFR200R03-D	2	20	0,3	5	15	6,7	XC4505							●								⑥	
7820313	PFR200R05-D	2	20	0,5	5	15	6,7	XC4505							●								⑥	
7820314	PFR200R10-D	2	20	1	5	15	6,7	XC4505							●								⑥	

Milling | Indexables



Inserts

CUTTING CONDITIONS

Milling | Indexables | Cutting conditions

PFR-ST, PFR-SH

Standard conditions

	Work Material	Tensile Strength / Hardness	Cutting Speed Vc (m/min)			Depth of Cut ap (mm)	Feed per Tooth fz (mm/t)			
			L/D				D			
			2,5D	5D	8D		Ø 6,7	Ø 8~11	Ø 12~17	Ø 20~32
P	Mild Steel-Carbon Steel S5400 - S10C	~180HB	200 (150~250)	80%	60%	0,05Dc	0,12	0,2	0,22	0,25
	Carbon Steel-Alloy Steel S50C - SCM440	~280HB	180 (150~250)	80%	60%	0,05Dc	0,15	0,18	0,22	0,25
	Die Steel SKD11 - SKD61	~280HB	150 (120~200)	80%	60%	0,05Dc	0,1	0,15	0,18	0,2
M	Stainless Steel (SUS304 - SUS420)	~250HB	150 (100~200)	80%	60%	0,03Dc	0,08	0,12	0,15	0,18
K	Cast Iron FC250	~300N/mm ²	200 (150~250)	80%	60%	0,05Dc	0,15	0,2	0,25	0,3
	Ductile Cast Iron FCD400	~600N/mm ²	150 (100~200)	80%	60%	0,05Dc	0,12	0,15	0,2	0,25
N	Aluminium Alloy	~13%Si	300 (200~400)	80%	60%	0,05Dc	0,2	0,25	0,3	0,35
S	Superalloy (Wet) (Inconel 718)	-	30 (20~40)	80%	60%	0,02Dc	0,04	0,05	0,08	0,12
	Titanium Alloy (Wet) (Ti-Al-4V)	-	50 (40~60)	80%	60%	0,02Dc	0,05	0,08	0,1	0,15
H	Pre-hardened Steel (NAK80, STAVAX)	40 ~ 43HRC	120 (100~150)	80%	60%	0,03Dc	0,08	0,1	0,12	0,18
	Die Cast Steel (DAC55, DH31)	43 ~ 48HRC	80 (50~100)	80%	60%	0,025Dc	0,05	0,08	0,1	0,15
	Hardened Steel (SKD11)	50 ~ 60HRC	60 (40~80)	80%	60%	0,02Dc	0,04	0,05	0,08	0,1

PFR-D

Standard conditions

	Work Material	Cutting Speed Vc (m/min)			Depth of Cut ap (mm)	Feed per Tooth fz (mm/t)			
		L/D				D			
		2,5D	5D	8D		Ø 6,7	Ø 8~11	Ø 12~17	Ø 20~32
N	Graphite	250 (150~350)	80%	60%	0,1Dc	0,25	0,4	0,5	0,5
	CFRP Carbon Fiber Reinforced Plastic	200 (150~250)	80%	60%	0,5Dc	0,05	0,1	0,15	0,2



CUTTING CONDITIONS

Milling | Indexables | Cutting conditions

PFR - High speed finishing conditions

Steel shank

	Work Material	Tensile Strength / Hardness	Milling Speed Vc (m/min)	Depth of Cut ap (mm)	Feed per Tooth fz (mm/t)			
					D			
					Ø 6~8	Ø 10~13	Ø 16~21	Ø 25~32
P	Mild Steel-Carbon Steel SS400 - S10C	~180HB	450	0,02Dc	0,1	0,12	0,14	0,18
	Carbon Steel-Alloy Steel S50C - SCM440	~280HB	450	0,02Dc	0,07	0,1	0,12	0,14
	Die Steel SKD11 - SKD61	~280HB	375	0,02Dc	0,07	0,1	0,12	0,14
M	Stainless Steel (SUS304 - SUS420)	~250HB	375	0,02Dc	0,07	0,12	0,14	0,17
K	Cast Iron FC250	~300N/mm ²	600	0,02Dc	0,12	0,14	0,18	0,22
	Ductile Cast Iron FCD400	~600N/mm ²	450	0,02Dc	0,1	0,12	0,14	0,18
N	Aluminium Alloy	~13%Si	750	0,03Dc	0,12	0,14	0,18	0,22
S	Superalloy (Wet) (Inconel 718)	-	70	0,015Dc	0,04	0,05	0,06	0,06
	Titanium Alloy (Wet) (Ti-Al-4V)	-	120	0,02Dc	0,06	0,08	0,11	0,13
H	Pre-hardened Steel (NAK80, STAVAX)	40 ~ 43HRC	300	0,015Dc	0,06	0,07	0,08	0,1
	Die Cast Steel (DAC55, DH31)	43 ~ 48HRC	270	0,015Dc	0,05	0,06	0,07	0,07
	Hardened Steel (SKD11)	50 ~ 60HRC	220	0,01Dc	0,05	0,06	0,07	0,07

PFR - High speed finishing conditions

Carbide shank short type

	Work Material	Tensile Strength / Hardness	Milling Speed Vc (m/min)	Depth of Cut ap (mm)	Feed per Tooth fz (mm/t)			
					D			
					Ø 6~8	Ø 10~13	Ø 16~21	Ø 25~32
P	Mild Steel-Carbon Steel SS400 - S10C	~180HB	540	0,02Dc	0,1	0,12	0,14	0,18
	Carbon Steel-Alloy Steel S50C - SCM440	~280HB	540	0,02Dc	0,07	0,1	0,12	0,14
	Die Steel SKD11 - SKD61	~280HB	450	0,02Dc	0,07	0,1	0,12	0,14
M	Stainless Steel (SUS304 - SUS420)	~250HB	450	0,02Dc	0,07	0,12	0,14	0,17
K	Cast Iron FC250	~300N/mm ²	720	0,02Dc	0,12	0,14	0,18	0,22
	Ductile Cast Iron FCD400	~600N/mm ²	540	0,02Dc	0,1	0,12	0,14	0,18
N	Aluminium Alloy	~13%Si	600	0,03Dc	0,12	0,14	0,18	0,22
S	Superalloy (Wet) (Inconel 718)	-	80	0,015Dc	0,04	0,05	0,06	0,06
	Titanium Alloy (Wet) (Ti-Al-4V)	-	150	0,02Dc	0,06	0,08	0,11	0,13
H	Pre-hardened Steel (NAK80, STAVAX)	40 ~ 43HRC	340	0,015Dc	0,06	0,07	0,08	0,1
	Die Cast Steel (DAC55, DH31)	43 ~ 48HRC	290	0,015Dc	0,05	0,06	0,07	0,07
	Hardened Steel (SKD11)	50 ~ 60HRC	260	0,01Dc	0,05	0,06	0,07	0,07

Milling | Indexables



Cutting conditions

CUTTING CONDITIONS

Milling | Indexables | Cutting conditions

PFR - High speed finishing conditions

Carbide shank long type

	Work Material	Tensile Strength / Hardness	Milling Speed Vc (m/min)	Depth of Cut ap (mm)	Feed per Tooth fz (mm/t)			
					D			
					Ø 6~8	Ø 10~13	Ø 16~21	Ø 25~32
P	Mild Steel-Carbon Steel SS400 - S10C	~180HB	480	0,02Dc	0,1	0,12	0,14	0,18
	Carbon Steel-Alloy Steel S50C - SCM440	~280HB	480	0,02Dc	0,07	0,1	0,12	0,14
	Die Steel SKD11 - SKD61	~280HB	400	0,02Dc	0,07	0,1	0,12	0,14
M	Stainless Steel (SUS304 - SUS420)	~250HB	400	0,02Dc	0,07	0,12	0,14	0,17
K	Cast Iron FC250	~300N/mm ²	640	0,02Dc	0,12	0,14	0,18	0,22
	Ductile Cast Iron FCD400	~600N/mm ²	480	0,02Dc	0,1	0,12	0,14	0,18
N	Aluminium Alloy	~13%Si	800	0,03Dc	0,12	0,14	0,18	0,22
S	Superalloy (Wet) (Inconel 718)	-	80	0,015Dc	0,04	0,05	0,06	0,06
	Titanium Alloy (Wet) (Ti-Al-4V)	-	144	0,02Dc	0,06	0,08	0,11	0,13
H	Pre-hardened Steel (NAK80, STAVAX)	40 ~ 43HRC	320	0,015Dc	0,06	0,07	0,08	0,1
	Die Cast Steel (DAC55, DH31)	43 ~ 48HRC	288	0,015Dc	0,05	0,06	0,07	0,07
	Hardened Steel (SKD11)	50 ~ 60HRC	240	0,01Dc	0,05	0,06	0,07	0,07

PFR - High speed finishing conditions

Carbide shank extra long type

	Work Material	Tensile Strength / Hardness	Milling Speed Vc (m/min)	Depth of Cut ap (mm)	Feed per Tooth fz (mm/t)			
					D			
					Ø 6~8	Ø 10~13	Ø 16~21	Ø 25~32
P	Mild Steel-Carbon Steel SS400 - S10C	~180HB	360	0,02Dc	0,1	0,12	0,14	0,18
	Carbon Steel-Alloy Steel S50C - SCM440	~280HB	360	0,02Dc	0,07	0,1	0,12	0,14
	Die Steel SKD11 - SKD61	~280HB	300	0,02Dc	0,07	0,1	0,12	0,14
M	Stainless Steel (SUS304 - SUS420)	~250HB	300	0,02Dc	0,07	0,12	0,14	0,17
K	Cast Iron FC250	~300N/mm ²	480	0,02Dc	0,12	0,14	0,18	0,22
	Ductile Cast Iron FCD400	~600N/mm ²	360	0,02Dc	0,1	0,12	0,14	0,18
N	Aluminium Alloy	~13%Si	600	0,03Dc	0,12	0,14	0,18	0,22
S	Superalloy (Wet) (Inconel 718)	-	60	0,015Dc	0,04	0,05	0,06	0,06
	Titanium Alloy (Wet) (Ti-Al-4V)	-	110	0,02Dc	0,06	0,08	0,11	0,13
H	Pre-hardened Steel (NAK80, STAVAX)	40 ~ 43HRC	240	0,015Dc	0,06	0,07	0,08	0,1
	Die Cast Steel (DAC55, DH31)	43 ~ 48HRC	220	0,015Dc	0,05	0,06	0,07	0,07
	Hardened Steel (SKD11)	50 ~ 60HRC	180	0,01Dc	0,05	0,06	0,07	0,07



SWEDEN

Branch office of OSG SCANDINAVIA
Abrahams Gränd 8
295 35 Bromölla
Sweden
Tel: +46 40 41 22 55
Fax: +46 40 41 32 55
osg@osg-scandinavia.com

OSG SCANDINAVIA

(For Scandinavian countries)
Langebjergvaenget 16
4000 Roskilde
Denmark
Tel.: +45 46 75 65 55
Fax: +45 46 75 67 00
osg@osg-scandinavia.com

OSG NETHERLANDS

Bedrijfsweg 5 - 3481 MG Harmelen
Postbus 50 - 3480 DB Harmelen
The Netherlands
Tel.: +31 348 44 2764
Fax: +31 348 44 2144
info@osg-nl.com

OSG UK

Shelton house, 5 Bentalls
Pipps Hill Ind Est, Basildon Essex SS14 3BY
United Kingdom
Tel.: +44 845 305 1066
Fax: +44 845 305 1067
sales@osg-uk.com

OSG EUROPE LOGISTICS

Avenue Lavoisier 1
B-1300 Z.I. Wavre - Nord
Belgium
Tel.: +32 10 23 05 07
Fax: +32 10 23 05 11
info@osgeurope.com

OSG BELUX

Avenue Lavoisier 1
B-1300 Z.I. Wavre - Nord
Belgium
Tel.: +32 10 23 05 11
Fax: +32 10 23 05 31
info@osg-belgium.com

OSG IBERICA

Bekolarra 4
E - 01010 Vitoria-Gasteiz
Spain
Tel.: +34 945 242 400
Fax: +34 945 228 883
osg-comaher@osg-comaher.com

OSG FRANCE

Paris Nord 2 385 rue de la Belle Etoile,
4 allée du Ponant
BP 66191 Roissy en France
F-95974 Roissy Ch. De Gaulle Cedex
France
Tel.: +33 1 49 90 10 10
Fax: +33 1 49 90 10 15
sales@osg-france.com

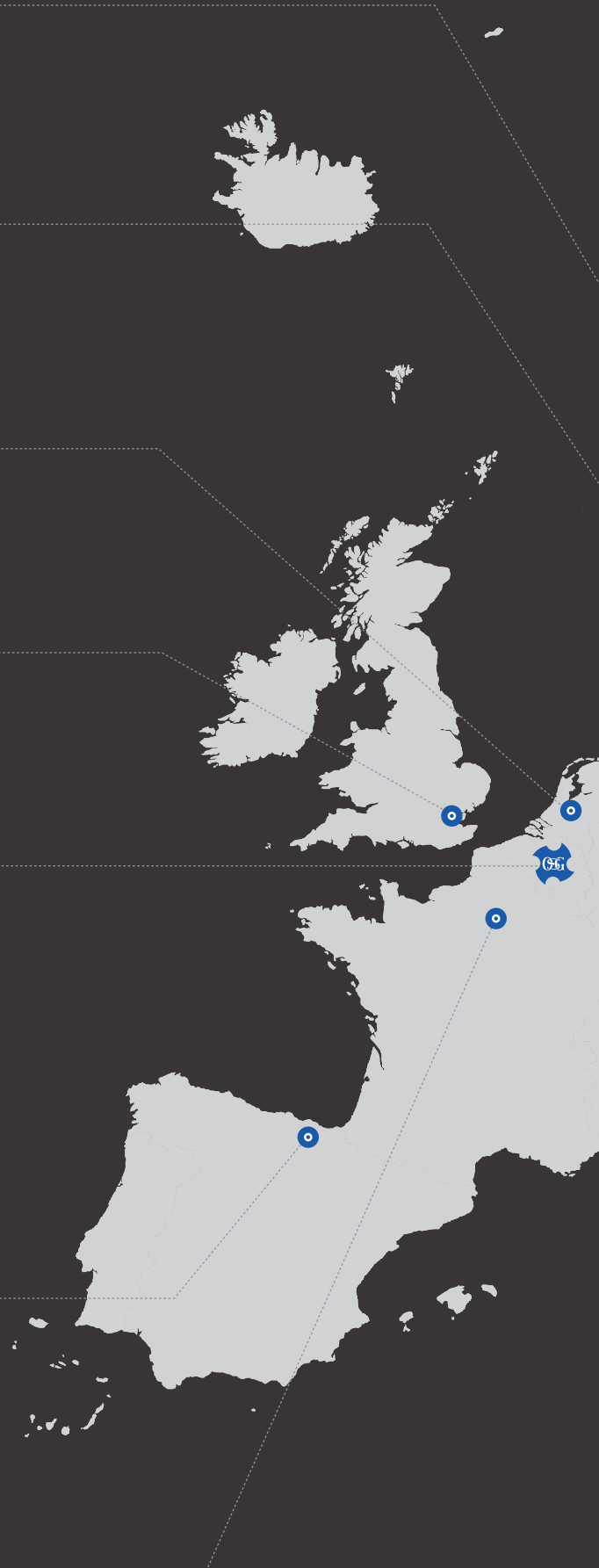



SLOVAKIA

Branch office of OSG Belgium s.a.
Tel: +32 10 23 05 04
Fax: +32 10 23 05 31
info@osg-belgium.com

OSG POLAND

Spółdzielcza 57
05-07 Halinów
Poland

OSG RUSSIA

Butlerova street, 17B, office 5069
117342 Moscow
Russia
Tel: +7 (495) 150 41 54
info@osg-russia.com

ROMSAN INTERNATIONAL CO. SRL

Reprezentant Exclusiv OSG
23-25, Nerva Traian Street
031044 Bucuresti
România
Tel: +40 021 322 07 47
Fax: +40 021 321 56 00
romsan.int@romsan.ro

OSG TURKEY

Rami Kişla Cad.No:56 Eyüp
Istanbul 34056
Turkey
Tel:+90 212 565 24 00
Fax: +90 212 565 44 00
info@osg-turkey.com

OSG ITALIA

Via Cirenaica n. 52 int. 61/63
I - 10142 Torino
Italy
Tel.: +39 0117705211
Fax: +39 0117071402
info@osg-italia.it

OSG GERMANY

Karl-Ehmann-Str. 25
D - 73037 Göppingen
Germany
Tel.: +49 7161 6064 - 0
Fax: +49 7161 6064 - 444
info@osg-germany.de



shaping your dreams

OSG EUROPE LOGISTICS

Avenue Lavoisier 1
B-1300 Z.I. Wavre - Nord - Belgium
Tel: +32 10 23 05 07
Fax: +32 10 23 05 51
info@osgeurope.com

OSG BELUX

Avenue Lavoisier 1
B-1300 Z.I. Wavre - Nord - Belgium
Tel: +32 10 23 05 11
Fax: +32 10 23 05 31
info@osg-belgium.com

OSG FRANCE

Parc Icade, Paris Nord 2
Immeuble "Le Rimbaud"
22 Avenue des Nations
CS66191 - 93420 Villepinte - France
Tel: +33 1 49 90 10 10
Fax: +33 1 49 90 10 15
sales@osg-france.com

OSG NETHERLANDS

Bedrijfsweg 5 - 3481 MG Harmelen
Tel: +31 348 44 2764
Fax: +31 348 44 2144
info@osg-nl.com

OSG UK

Shelton house, 5 Bentalls
Pipps Hill Ind Est, Basildon Essex SS14 3BY
Tel: +44 845 305 1066
Fax: +44 845 305 1067
sales@osg-uk.com

SLOVAKIA

Branch office of OSG Europe Logistics s.a.
Tel (SK) +421 2 4329 1295
Tel (BE) +32 10 23 05 07
Fax (BE) +32 10 23 05 51
sales-osgsvk@osgeurope.com

OSG POLAND Sp. z.o.o.

Spółdzielcza 57
05-07 Halinów - Poland
Tel: +22 760 82 71
Fax: +22 760 82 71
osg@osg-poland.com

OSG GERMANY

Karl-Ehmann-Str. 25
D - 73037 Göppingen - Germany
Tel: +49 7161 6064 - 0
Fax: +49 7161 6064 - 444
info@osg-germany.de

OSG SCANDINAVIA

(For Scandinavian countries)
Langebjergvaenget 16
4000 Roskilde - Denmark
Tel: +45 46 75 65 55
Fax: +45 46 75 67 00
osg@osg-scandinavia.com

SWEDEN

Branch office of OSG SCANDINAVIA
Abrahams Gränd 8
295 35 Bromölla - Sweden
Tel: +46 40 41 22 55
Fax: +46 40 41 32 55
osg@osg-scandinavia.com

OSG IBERICA

Bekolarra 4
E - 01010 Vitoria-Gasteiz - Spain
Tel: +34 945 242 400
Fax: +34 945 228 883
osg-comaher@osg-comaher.com

RUSSIA

Butlerova street, 17B, office 5069
117342 Moscow - Russia
Tel: +7 (495) 150 41 54
info@osg-russia.com

OSG TURKEY

Rami Kışla Cad.No:56 Eyüp
Istanbul 34056 - Turkey
Tel:+90 212 565 24 00
Fax: +90 212 565 44 00
info@osg-turkey.com

ROMSAN INTERNATIONAL CO. SRL

Reprezentant Exclusiv OSG
23-25, Nerva Traian Street
031044 Bucuresti - România
Tel: +40 021 322 07 47
Fax: +40 021 321 56 00
romsan.int@romsan.ro

AUSTRIA

Branch office of OSG GERMANY
Messestraße 11
A-6850 Dornbirn
Tel: +49 7161 6064-0
Fax: +49 7161 6064-444
info@osg-germany.de

OSG ITALIA

Via Cirenaiica n. 52 int. 61/63
I - 10142 Torino - Italy
Tel: +39 0117705211
Fax: +39 0117071402
info@osg-italia.it

WEXO PRÄZISIONSWERKZEUGE GmbH

Siemensstraße 13
D-61352 Bad Homburg
Tel: (06172) 10 62 06
Fax: (06172) 10 62 13
verkauf@wexo.com

OSG EUROPE LOGISTICS S.A.

08/2017 - All rights reserved. © OSG Europe 2017.

The contents of this catalogue are provided to you for viewing only. They are not intended for reproduction either in part or in whole in this or other medium. They cannot be copied, used to create derivation work or used for any reason, by means without the express, written permission of the copyright owner. If prices are stated, they are netto unit-prices and any eventual tax(es) have to be added. The company is not responsible for any printing error in technical, price and/or any other data.

Tool specifications subject to change without notice.

www.osgeurope.com

